

PROJECT MANUAL

PROJECT NAME AND LOCATION:

**EMERSON APARTMENTS, BUILDINGS J, N & U
FIREPLACE & BATHROOM FAN REPLACEMENT**

Contract Number: DW2400431

TABLE OF CONTENTS

- 02 Invitation to Bid (1 Page)
- 03 Specifications (21 Pages)
- 04 Plans (1 Sheet)
- 05 Instruction to Bidders (6 Pages)
- 06 General Conditions (15 Pages)
- 07 Bid Form & Bidder Information (4 Pages) – ***Return with Bid***
- 08 Sample Contract Form (1 Page)
- 09 Sample Certificate of Insurance (2 Pages)

INVITATION TO BID

King County Housing Authority (KCHA) will accept bids from qualified general contractors to furnish labor, materials and necessary equipment to perform the following:

SCOPE OF WORK: Work includes, but is not limited to, remove and replace existing fireplace inserts & bath fans, heat lamps, switches, and other tasks as described in the bid documents.

PROJECT MANUAL DISTRIBUTION:

Address: King County Housing Authority, 600 Andover Park, Seattle, WA 98188
Distribution: * Documents are available for download on KCHA's website at <http://www.kcha.org/business/construction/open/>

PRE-BID CONFERENCE:

Date and Time: 1/17/2024 at 11:00 A.M.
Jobsite Address: Emerson Apartments, 11010 NE 124th Lane, Kirkland, WA 98034.
In Addition: Contractors are strongly encouraged to attend the Pre-Bid Conference. Failure to attend the Conference will not relieve the Contractor of any responsibility for information provided at that time.
For Questions: Questions pertaining to the bid are to be sent via email to MichelleJ@kcha.org no later than seven (7) calendar days prior to bid due date. All responses shall be in the form of Addenda.
Posting: Addenda will be posted on KCHA's website.

BIDS ARE DUE:

Time: 3:00 pm
Date: January 30, 2024

Address: King County Housing Authority, 600 Andover Park West, Tukwila, WA 98188
Submittal Process: * Bids may be sent to Michelle Jackson via email to MichelleJ@kcha.org or mail to the above address attn.: Michelle Jackson

Process: All Bids must be received by KCHA no later than the above due date and time. No Bids will be accepted after that date and time.

BID GUARANTEE: Not Required.

PERFORMANCE AND PAYMENT BONDS: As a condition of award Performance and Payment bonds for 100% of the Contract Award Amount shall be furnished for the Work. On contracts of one hundred fifty thousand dollars (\$150,000.00) or less, at Contractors option the requirement may be waived in lieu of an additional 5% (total 10%) retainage.

KCHA is an Equal Employment Opportunity Employer and strongly encourages minority-owned and women-owned businesses, socially and economically disadvantaged businesses, and small businesses to submit bids or to participate as subcontractors and suppliers on KCHA Contracts.

KCHA reserves the right to reject any or all bids or to waive any informality in the bidding. No bid shall be withdrawn for a period of 60 calendar days subsequent to the opening of the bids without the written consent of KCHA.

CONTACT PERSON: Michelle Jackson at MichelleJ@kcha.org

SPECIFICATIONS

**Fireplace & Bathroom Fan & Fireplace Replacements
Emerson Apartments**

**Contract Number: DW2400431
Page 1 of 17**

SECTION 01100 - SUMMARY

PART 1 - GENERAL

1.1 WORK COVERED BY CONTRACT DOCUMENTS

- A. Project Identification: Fireplace and Bathroom Fan Replacements
- B. Work consists of replacement of fireplace and bathroom fans.
- C. Project Location
 - 1. Emerson Apartments, 11010 NE 124th Lane, Kirkland, WA 98034
 - a. Building J – 12 Units, 18 Bath Fans, 6 Fireplaces, 1 Chimney Stacks.
 - b. Building N – 9 Units, 18 Bath Fans, 9 Fireplaces, 1 Chimney Stacks.
 - c. Building U – 12 Units, 18 Bath Fans, 6 Fireplaces, 2Chimney Stacks.
 - d. Totals: 33 Apartment Units, 56 Bath Fans, 21 Fireplaces, 4 Chimney Stacks
- D. Work includes:
 - 1. Fireplaces
 - a. Removal of existing fireplace insert.
 - b. Rockwool insulation in chimney stack.
 - c. Removal of chimney cap.
 - d. Cut back chimney stack as necessary to install new blank cap.
 - e. Provide electric fireplace insert and powder coated surround.
 - 2. Bath Fans (one fan per bathroom)
 - a. Removal of existing bath fans, heat lamps, switches and attic ducting.
 - b. Supply and installation of new bath fans and switches.
 - c. On lower floors connect to existing duct.
 - d. At upper floors provide 4-inch insulated rigid metal duct, insulation and connect to termination caps at roofline.

1.2 WORK SEQUENCE

- A. The Work shall be completed in 60 calendar days from the date of Notice to Proceed.

1.3 LIQUIDATED DAMAGES

SPECIFICATIONS

**Fireplace & Bathroom Fan & Fireplace Replacements
Emerson Apartments**

**Contract Number: DW2400431
Page 2 of 17**

- A. Liquidated damages will be assessed for each calendar day that the Contractor exceeds the time for completion in the amount of \$250.

1.4 WORK RESTRICTIONS

A. Use of the Premises

- 1. Use of Site: Limit use of premises to work areas. Do not disturb portions of site beyond areas in which the Work is indicated.
 - a. Owner Occupancy: Allow for resident occupancy of site. Owner will occupy site and existing building during entire construction period. Cooperate with Owner during construction operations to minimize conflicts and facilitate resident usage.
 - b. Driveways and Entrances: Keep driveways and entrances serving premises clear and available to residents and emergency vehicles at all times. Do not use these areas for parking or storage of materials.
- 2. Use of Existing Building: Maintain existing building in a weathertight condition throughout construction period. Repair damage caused by construction operations. Protect property, the buildings and occupants during construction period.

B. Occupancy Requirements

- 1. Full Owner Occupancy: Owner and tenants will occupy site and existing building during entire construction period. Cooperate with Owner during construction operations to minimize conflicts and facilitate Owner and tenant usage. Perform the Work so as not to interfere with Owner's operations.

1.5 PAYMENT PROCEDURES

- A. Coordinate preparation of the Schedule of Values with preparation of Contractor's Construction Schedule.
- B. Each Application for Payment shall be consistent with previous applications and payments.
- C. Entries shall match data on the Schedule of Values and Contractor's Construction Schedule. Use updated schedules if revisions were made.
- D. Waivers of Lien: With each Application for Payment, submit conditional waivers lien from every entity that is lawfully entitled to file a lien arising out of the Contract and related to the Work covered by the payment.
 - 1. Submit partial waivers on each item for amount requested, before deduction for retainage, on each item.
 - 2. When an application shows completion of an item, submit final or full waivers.
 - 3. Owner reserves the right to designate which entities involved in the Work must submit waivers.

SPECIFICATIONS

**Fireplace & Bathroom Fan & Fireplace Replacements
Emerson Apartments**

**Contract Number: DW2400431
Page 3 of 17**

- a. Submit final Application for Payment with or preceded by final waivers from every entity involved with performance of the Work covered by the application who is lawfully entitled to a lien.

- E. Final Payment Application: Submit final Application for Payment with releases and close out supporting documentation.

1.6 PROJECT MEETINGS

- A. Preconstruction Conference: Schedule a preconstruction conference before starting construction, at a time convenient to Owner, but no later than seven days after execution of the Agreement.

1.7 SUBMITTALS

- A. Provide product data for each element of construction and type of product or equipment for approval by Owner.
- B. Subcontract list. Prepare written information that demonstrates capabilities and experience of firm or persons.
- C. Contractors project manager and/or supervisors. Prepare written information that demonstrates capabilities and experience of firm or persons.
 - 1. The Owner will review subcontractors and assigned staff and will accept or reject based on experience or qualifications.
- D. The Contractor shall submit a site-specific safety plan to the Owner's representative prior to the initial scheduled construction meeting.

1.8 TEMPORARY FACILITIES

- A. Sanitary Facilities: Provide temporary toilets, wash facilities, and drinking-water fixtures. Comply with regulations and health codes for type, number, location, operation, and maintenance of fixtures and facilities.
- B. Barricades, Warning Signs and Lights: Comply with standards and code requirements for erection of structurally adequate barricades. Paint with appropriate colors, graphics and warning signs to inform personnel and the public of the hazard being protected against.
- C. Use of Owner's existing electric power service will be permitted, as long as equipment is maintained in a condition acceptable to Owner.
- D. Four parking spaces shall be available to the contractor for storage containers and parking.

1.9 EXECUTION REQUIREMENTS

SPECIFICATIONS

**Fireplace & Bathroom Fan & Fireplace Replacements
Emerson Apartments**

**Contract Number: DW2400431
Page 4 of 17**

- A. General: Clean Project site and work areas daily, including common areas. Coordinate progress cleaning for joint-use areas where more than one installer has worked. Enforce requirements strictly. Dispose of materials lawfully.

1.10 CUTTING AND PATCHING

A. Quality Assurance

1. Structural Elements: Do not cut and patch structural elements in a manner that could change their load-carrying capacity or load-deflection ratio.
2. Visual Requirements: Do not cut and patch construction in a manner that results in visual evidence of cutting and patching. Do not cut and patch construction exposed on the exterior or in occupied spaces in a manner that would, in Owner's opinion, reduce the building's aesthetic qualities. Remove and replace construction that has been cut and patched in a visually unsatisfactory manner.

B. Performance

1. Cutting: Cut existing construction by sawing, drilling, breaking, chipping, grinding, and similar operations, including excavation, using methods least likely to damage elements retained or adjoining construction. If possible, review proposed procedures with original Installer; comply with original Installer's written recommendations.
2. Patching: Patch construction by filling, repairing, refinishing, closing up, and similar operations following performance of other Work. Patch with durable seams that are as invisible as possible. Provide materials and comply with installation requirements specified in other Sections of these Specifications.
 - a. Exposed Finishes: Restore exposed finishes of patched areas and extend finish restoration into retained adjoining construction in a manner that will eliminate evidence of patching and refinishing.
 - b. Exterior Building Enclosure: Patch components in a manner that restores enclosure to a weathertight condition.

1.11 SELECTIVE DEMOLITION

A. Hazardous Materials

1. The property was constructed in 1983.
2. Comply with all applicable laws regarding removal and disposal of hazardous materials.
3. If materials are encountered that are suspected of containing hazardous materials, do not disturb and immediately notify Owner.

- B. Utility Service: Maintain existing utilities indicated to remain in service and protect them against damage during selective demolition operations.

1.12 CLOSEOUT PROCEDURES

SPECIFICATIONS

**Fireplace & Bathroom Fan & Fireplace Replacements
Emerson Apartments**

**Contract Number: DW2400431
Page 5 of 17**

- A. General: Provide daily and final cleaning. Conduct cleaning and waste-removal operations to comply with local laws and ordinances and Federal and local environmental and antipollution regulations. All waste materials are to be removed and disposed of offsite.
 - 1. Prior to acceptance of the work at each building, clean project site, yard, and grounds, in areas disturbed by construction activities, including landscape development areas, of rubbish, waste material, litter, and other foreign substances.
- B. At final completion and prior to final payment submit written warranties indicated in other sections.

1.13 WARRANTY

- A. Prior to final acceptance and final payment, the Contractor shall furnish all labor and material, equipment, services and perform and complete all work required, with a workmanship guarantee for two (2) years from date of completion.

PART 2 - PRODUCTS (Not Used)

PART 3 - EXECUTION (Not Used)

END OF SECTION 01100

SPECIFICATIONS

**Fireplace & Bathroom Fan & Fireplace Replacements
Emerson Apartments**

**Contract Number: DW2400431
Page 6 of 17**

SECTION 07210 - BUILDING INSULATION

PART 1 - GENERAL

1.1 SECTION INCLUDES

- A. Rockwool insulation for top and bottom of chimney stack, and at all fireplace insert locations. Completely stuff the cavities to prevent any air flow and to provide fire stopping.
- B. Duct wrap blanket insulation at bath fan ducts in attic space. Minimum R-4 (R-11 with unfaced fiberglass insulation).

1.2 SUBMITTALS

- A. Product Data: Manufacturer's data sheets on each product.

PART 2 - PRODUCTS

2.1 MANUFACTURERS

- A. Nu-Wool Company, Inc., 2472 Port Sheldon Street, Jenison, Michigan 49428. Toll Free (800) 748-0128. Phone (616) 669-0100. Fax (616) 669-2370. Website www.nuwool.com. E-mail info@nuwool.com.

PART 3 - EXECUTION

3.1 INSTALLATION

- A. Pack insulation to refusal in the bottom and top of the chimney stack to ensure fire rating.

END OF SECTION 07210

SPECIFICATIONS

**Fireplace & Bathroom Fan & Fireplace Replacements
Emerson Apartments**

**Contract Number: DW2400431
Page 7 of 17**

SECTION 07620 - SHEET METAL FLASHING AND TRIM

PART 1 - GENERAL

1.1 SUMMARY

A. This Section includes the following:

1. Chimney chase cover

1.2 SUBMITTALS

- A. Product Data: For each product indicated.
- B. Shop drawing.

1.3 QUALITY ASSURANCE

- A. Sheet Metal Flashing and Trim Standard: Comply with SMACNA's "Architectural Sheet Metal Manual." Conform to dimensions and profiles shown unless more stringent requirements are indicated.

SPECIFICATIONS

**Fireplace & Bathroom Fan & Fireplace Replacements
Emerson Apartments**

**Contract Number: DW2400431
Page 8 of 17**

PART 2 - PRODUCTS

2.1 SHEET METAL FABRICATIONS

- A. 24 gauge galvanized chimney chase cover sized to match the chase. Include slope to shed water and drip edge with hemmed edges. All joints shall be soldered and fastened with #10 galvanized screws and rubber washers.

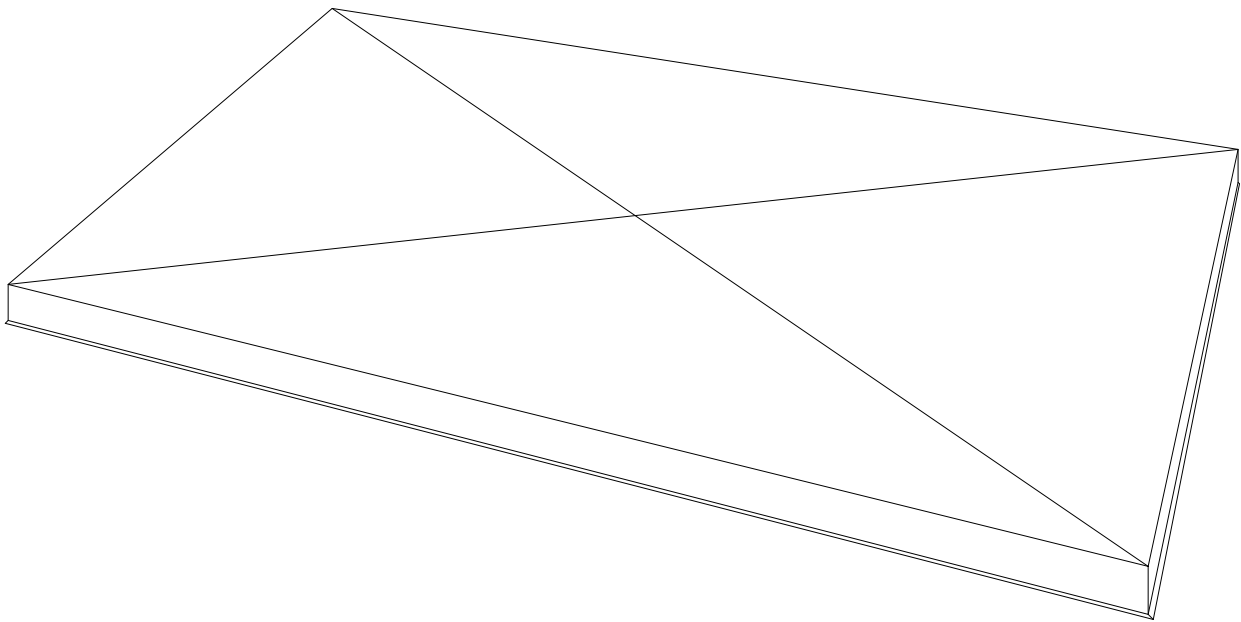

PART 3 - EXECUTION

3.1 INSTALLATION

- A. Cut back existing chimney stack to allow for installation of the cap.
- B. General: Install sheet metal flashing and trim to comply with performance requirements and SMACNA's "Architectural Sheet Metal Manual." Provide concealed fasteners where possible, set units true to line, and level as indicated. Install work with laps, joints, and seams that will be permanently watertight.

END OF SECTION 07620

SPECIFICATIONS

SECTION 09260 - GYPSUM BOARD ASSEMBLIES

PART 1 - GENERAL

1.1 SUMMARY

- A. This Section includes interior gypsum wallboard to repair damaged gypsum wall board (GWB) during installation of fans and fireplaces. Any GWB that is damaged during installation is to be restored to match existing.

PART 2 - PRODUCTS

2.1 PANEL PRODUCTS

- A. Gypsum Wallboard: ASTM C 36.

2.2 TRIM ACCESSORIES

- A. Interior Trim: ASTM C 1047.

2.3 JOINT TREATMENT MATERIALS

- A. General: Comply with ASTM C 475.
- B. Joint Tape: Interior Gypsum Wallboard: Paper.
- C. Joint Compound for Interior Gypsum Wallboard: For each coat use fire resistant compound formulation that is compatible with other compounds applied on previous or for successive coats.

2.4 AUXILIARY MATERIALS

- A. General: Provide auxiliary materials that comply with referenced installation standards and manufacturer's written recommendations.

2.5 TEXTURE FINISHES

- A. Primer: As recommended by textured finish manufacturer.
- B. Aggregate Finish: Water-based, job-mixed, aggregated, drying-type texture finish for spray application.
 - 1. Texture: Match existing.

SPECIFICATIONS

**Fireplace & Bathroom Fan & Fireplace Replacements
Emerson Apartments**

Contract Number: DW2400431
Page 10 of 17

PART 3 - EXECUTION

3.1 INSTALLATION

- A. Gypsum Board: Comply with ASTM C 840 and GA-216.
- B. Water-Resistant Gypsum Backing Board: Install with 1/4-inch gap where panels abut other construction or penetrations.
- C. Provide texture to match existing.

END OF SECTION 09260

SPECIFICATIONS

**Fireplace & Bathroom Fan & Fireplace Replacements
Emerson Apartments**

Contract Number: DW2400431
Page 11 of 17

SECTION 09911 - PAINTING

PART 1 - GENERAL

1.1 SUMMARY

- A. This Section includes surface preparation and field painting areas impacted by the installation of bath fans or fireplaces. Any GWB repairs or damaged paint surfaces caused by installations is to be restored to match existing.

PART 2 - PRODUCTS

2.1 GENERAL

- A. All colors used shall be selected by the Owner, from chips shown on color cards and/or fan deck selectors provided by manufacturer unless otherwise specified herein.
- B. Catalysts/Activators, solvent or paint additives are generally prohibited and may only be used with written approved from and authorized agent of and only if specifically approved by the manufacturer's printed literature or letter of acceptance.
- C. Products shall be provided as specified and no substitution or changes shall be allowed unless authorized in writing by the Owner. Contractor may submit a substitution request with supporting evidence that the product is equal in quality to the specified product. The Owner shall make the final determination as to whether a substitution shall be allowed.
- D. Where the manufacturer offers options on primers for a particular substrate, use primer categorized as "best" by the manufacturer.

2.2 CAULK & PATCHING

- A. Caulking: WL001360A - Sher-MAX Ultra Urethanized Elastomeric Sealant White.

2.3 PRIMER

- A. Exterior Primer: Exterior primer of finish coat manufacturer and recommended in writing by manufacturer for use with finish coat and on substrate indicated.
 - 1. B28W08111 - Premium Wall and Wood Primer

2.4 INTERIOR FINISH

- A. A86W00151 SuperPaint® Interior Acrylic Latex

SPECIFICATIONS

**Fireplace & Bathroom Fan & Fireplace Replacements
Emerson Apartments**

Contract Number: DW2400431
Page 12 of 17

1. Walls and Ceilings: Match existing
2. Kitchens, Baths, Laundry Rooms: Satin

PART 3 - EXECUTION

3.1 EXAMINATION

- A. Do not begin application of coatings until substrates have been properly prepared. Notify Owner of unsatisfactory conditions before proceeding.
- B. Proceed with work only after conditions have been corrected and approved by the Owner and the manufacturer.

3.2 SURFACE PREPARATION

- A. Proper product selection, surface preparation, and application affect coating performance. Coating integrity and service life will be reduced because of improperly prepared surfaces. Selection and implementation of proper surface preparation ensures coating adhesion to the substrate and prolongs the service life of the coating system.
- B. Selection of the proper method of surface preparation depends on the substrate, the environment, and the expected service life of the coating system. Economics, surface contamination, and the effect on the substrate will also influence the selection of surface preparation methods.

3.3 APPLICATION

- A. Paint complete plane in areas affected by construction, i.e. complete surface from corner to corner and floor to ceiling with no breaks.
 1. Include painting of access door and trim.
- B. Comply with procedures specified in PDCA P4 for inspection and acceptance of surfaces to be painted.

END OF SECTION 09911

SPECIFICATIONS

**Fireplace & Bathroom Fan & Fireplace Replacements
Emerson Apartments**

**Contract Number: DW2400431
Page 13 of 17**

SECTION 10310 - MANUFACTURED ELECTRIC FIREPLACES

PART 1 - GENERAL

1.1 SECTION INCLUDES

- A. Manufactured electric fireplaces.
- B. Fireplace accessories.

1.2 SUBMITTALS

- A. Product Data: Manufacturer's data sheets on each product to be used, including:
 - 1. Preparation instructions and recommendations.
 - 2. Storage and handling requirements and recommendations.
 - 3. Installation methods.
- B. Verification Samples: Provide one mock up for Owner's written approval.

1.3 WARRANTY

- A. Warranty: Provide manufacturer's standard warranty against defects in materials and workmanship.

PART 2 - PRODUCTS

2.1 MANUFACTURED ELECTRIC FIREPLACES

- A. General:
 - 1. Comply with applicable building codes.
 - 2. UL listed.
- B. PuraFlame Western 33 inch Electric fireplace insert:
 - 1. No Remote
 - 2. Dimensions as indicated in Owner's Manual

2.2 FIREPLACE ACCESSORIES

- A. Powder coated 24 gauge surround with hidden connection clips designed by Contractor.

SPECIFICATIONS

**Fireplace & Bathroom Fan & Fireplace Replacements
Emerson Apartments**

Contract Number: DW2400431
Page 14 of 17

PART 3 - EXECUTION

3.1 INSTALLATION

- A. Install in accordance with manufacturer's instructions, ANSI Z21.44 and the requirements of authorities having jurisdiction.
- B. Use manufacturer's guidelines for minimum clearances to combustibles, walls, and finishes.
- C. Anchor all components firmly in position for long life under hard use.
- D. Upon completion of installation, visually inspect all exposed surfaces. Touch up scratches and abrasions with touch up paint recommended by the manufacturer; make imperfections invisible to the unaided eye from a distance of 5 feet.

3.2 ELECTRICAL

- A. Locate junction box for outlet behind fireplace for plug in connection.
- B. Provide extension to existing circuit at nearest outlet.
- C. Disconnect heat source.

3.3 FIELD QUALITY CONTROL

- A. Upon completion of installation, visually inspect all exposed surfaces. Touch up scratches and abrasions with touch-up paint recommended by the manufacturer, make imperfections invisible to the unaided eye from a distance of 5 feet (1.5m).
- B. Test for proper operation, control and safety devices.
- C. Complete Installer's Warranty Validation Card.

3.4 PROTECTION

- A. Protect installed products until completion of project.
- B. Touch-up, repair or replace damaged products before Substantial Completion.

END OF SECTION 103100

SPECIFICATIONS

SECTION 15830 - FANS

PART 1 - GENERAL

1.1 SUMMARY

- A. This Section includes bath fans, ducts and switches.

1.2 SUBMITTALS

- A. Product Data
- B. Operation and maintenance data.

1.3 QUALITY ASSURANCE

- A. Electrical Components, Devices, and Accessories: Listed and labeled as defined in NFPA 70, Article 100, by a testing agency acceptable to authorities having jurisdiction, and marked for intended use.
- B. UL Standard: Power ventilators shall comply with UL 705.
- C. Testing
 - 1. Test each fan and exterior termination cap using balometer flow hood.
 - 2. Provide test data to Owner showing readings for each fan inside and outside.

PART 2 - PRODUCTS

2.1 BATHROOM EXHAUST FANS

- A. Panasonic Whisperceiling Fan/Light FV-0511VQL1 80 CFM selected.

2.2 CONTROL SWITCH

- A. Panasonic FV-WCCS2-W

2.3 DUCTS

- A. Lower floors: Existing ducts for lower floors connecting to new wall caps.
- B. Upper floors: 4-inch diameter insulated rigid metal vent pipe connected to new roof caps.

SPECIFICATIONS

2.4 TERMINATION CAP

- A. Lower floors: Broan Wall Termination Cap Model 885BL
- B. Upper floors: Broan Roof Termination Cap Model 636

2.5 INSULATION

- A. Minimum R-4 (R-11 with unfaced fiberglass insulation).

2.6 ACCESSORIES

- A. Accessories as required for a complete installation.
 - 1. #8 sheet-metal screws
 - 2. Foil-backed butyl tape UL 181B – Hardcast Foil-Grip 1402
 - 3. Mastic: Hardcast Versi-Grip 181 mastic
 - 4. Support material
 - 5. Electrical connection material including wiring, switch plates, etc

PART 3 - EXECUTION

3.1 INSTALLATION

- A. Install fans, ducts and switches in accordance with manufacturers written instructions and requirements of PSE and the AHJ.
 - 1. Connect ducts using mastic and/or tape.
 - 2. Suspend units from structure; use steel wire or metal straps.
- B. All mechanical ventilation fan exhaust ducting shall comply with the following:
 - 1. All exhaust fans shall be equipped with a back draft damper located at either the fan outlet or the vent termination.
- C. Air-tight and mechanically fastened at each joint using a minimum of two screws, and taped to the fan outlet and to the collar of termination cap.
- D. Ducts
 - 1. Connect to existing ducts at lower floors.
 - 2. Replace ducts at upper floors.
- E. Terminal Caps
 - 1. Replace all terminal caps installed as recommended to written industry standards.

SPECIFICATIONS

**Fireplace & Bathroom Fan & Fireplace Replacements
Emerson Apartments**

**Contract Number: DW2400431
Page 17 of 17**

2. Repair and make weather tight all roofing and exterior wall materials at new caps.

F. Insulation

1. Ducting in unconditioned space shall be insulated.

3.2 FIELD QUALITY CONTROL

A. Operational Test: After electrical circuitry has been energized, start units to confirm proper motor rotation and unit operation. Remove malfunctioning units, replace with new units, and retest.

B. Set timer and humidity controls at levels agreed with Owner in writing prior to installation.

C. Fan testing: Test fans at interior and exterior to verify flow using recently calibrated balometer.

1. Test results shall demonstrate flow in no less than 70 CFM.

2. Provide report listing all units and test results for approval.

3. Units showing less than 70 CFM shall be reinstalled until required flow is achieved.

END OF SECTION 15838

Specification Submittal Data / Panasonic Precision Spot Ventilation Fan/Light

Description:

Ventilating fan/light shall be Low Noise ceiling mount type rated for continuous run. Fan/light shall be ENERGY STAR® rated and certified by the Home Ventilation Institute (HVI). Evaluated by Underwriters Laboratories and conform to both UL and cUL safety standards.

Motor/Blower:

- Enclosed brushless ECM motor technology rated for continuous run.
- Fan ventilation rates shall be manually adjustable for 50-80-110 CFM.
- Power rating shall be 120 volts and 60 Hz.
- Fan shall be UL and cUL listed for tub/shower enclosure when GFCI protected and used in insulated ceiling (TYPE I.C.).
- Motor equipped with thermal-cutoff fuse.
- Removable with permanently lubricated plug-in motor.

Housing:

- 26 gauge Zinc-Aluminum-Magnesium (ZAM) housing.
- Integrated dual 4" or 6" diameter duct adapter.
- Built-in damper reduces back drafting and helps with blower door testing.
- Built-in metal flange provides blocking for penetrations through drywall as an Air Barrier, and assists with the decrease in leakage in the Building Envelope during blower door testing.
- Articulating and expandable installation bracket up to 24".

Ceiling Radiation Damper:

- WhisperCeiling® DC™ is UL listed for use with the Panasonic Ceiling Radiation Damper (Model #: PC-RD05C5, sold separately).

Grille:

- Attractive design using Poly Pro material.
- Attaches directly to housing with torsion springs.

Warranty:

- ECM Motor: 6 Years from original purchase date.
- LED Panel: 5 Years from original purchase date.
- ALL Parts: 3 Years from original purchase date.

Architectural Specifications:

Ventilation fan/light shall be UL and cUL listed for ceiling mount and tub/shower enclosure when GFCI protected. Fan/light shall also be ENERGY STAR® certified, with a built-in speed selector. Choose from 50-80-110 CFM and no more than <0.3/<0.3/0.4 sone as certified by the Home Ventilating Institute (HVI) at 0.1 static pressure in inches water gauge (w.g.) with no less than 50-83-110 CFM and no more than 0.4/0.6/0.9 sone as certified by HVI at 0.25 w.g. Power Consumption shall be no greater than 3.9/6.0/10.9 watts at 0.1 w.g. and 7.1/11.0/16.1 watts at 0.25 w.g., with efficiency of no less than 14.1/13.7/10.3 CFM/watt at 0.1 w.g. and 7.8/7.7/7.0 CFM/watt at 0.25 w.g. The motor shall be totally enclosed with a brushless ECM motor engineered to run continuously. ECM motor speed shall automatically increase when the fan senses static pressure to maintain selected CFM. Power rating shall be 120V/60Hz. Duct diameter shall be no less than 4", inclusive of an integrated dual 4" or 6" duct adapter. Lamp shall be of the LED dimmable type and

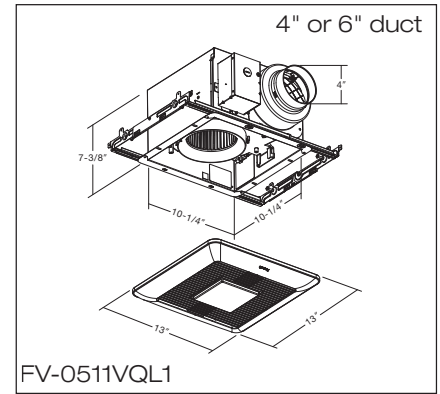

be no less than (1) 10W, ENERGY STAR® 2.0 certified, JA-8 compliant for CA Title 24, LED chip panel that maintains 50,000 hours rated average life and incorporates a <1W LED night light. Fan can be used to comply with ASHRAE 62.2, LEED, EarthCraft, IAP, California Title-24 and WA Ventilation Code.

Light:



(1) 10 Watt Dimmable LED chip panel/3000 Kelvin Warm White/90CRI/700 lumens/70 LPW/ ENERGY STAR 2.0 certified/JA-8 compliant for CA Title 24/50,000 hours rated average life /<1W LED night light.

Performance Curve 4" Duct

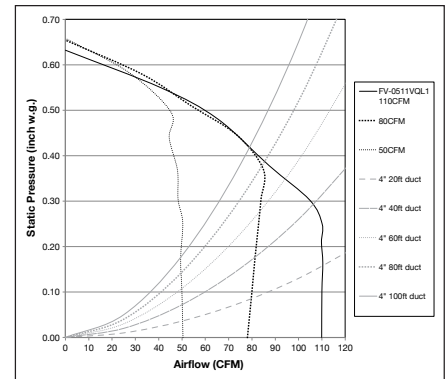

Specifications: WhisperCeiling DC FV-0511VQL1		4"		4"		4"	
Ventilation Fan Characteristics (HVI Certified Data)	Static Pressure in inches w.g.	0.1	0.25	0.1	0.25	0.1	0.25
	Air Volume (CFM)	110	110	80	83	50	50
	Noise (sones)	0.4	0.9	<0.3	0.6	<0.3	0.4
	Power Consumption (watts)	10.9	16.1	6.0	11.0	3.9	7.1
	Energy Efficiency (CFM/Watt)	10.3	7.0	13.7	7.7	14.1	7.8
	Speed (RPM)	1016	1268	867	1185	768	1097
	Current (amps)	0.18	0.26	0.11	0.19	0.07	0.12
	MAX. Current (amps)	0.30					
	Power Rating (V/Hz)	120/60					
	ENERGY STAR rated	Yes					

0.25=Installed Performance

For complete Installation Instructions visit us.panasonic.com/ventfans

Model	Quantity	Comments	Project:
			Location:
			Architect:
			Engineer:
			Contractor:
			Submitted by:
			Date:

Panasonic Eco Solutions North America
Eco Products Division
Two Riverfront Plaza
Newark, NJ 07102



ECM Motor Technology

When the fan senses static pressure, its speed is automatically increased to ensure that the desired CFM is not compromised, which allows the fan to perform as rated.

us.panasonic.com/ventfans



FV-WCCS1-W (White)

Condensation Sensor Plus – Fan Only

- Combination humidity and temperature sensor anticipates dew point, automatically turning the fan on.
- Adjustable Minutes Per Hour fan timer (0-60 mins) for compliance with ASHRAE 62.2.
- Moisture Sensitivity Selector allows fine tuning for dry or moist environments.
- Automatic Fan Control - 30 minute countdown timer initiates after moisture returns to normal levels.
- Manual Fan Control - 20 minute countdown timer initiates once fan is turned on.
- Blue LED indicates when the fan is on.
- Commercial Grade - 8 Amp max load, 2 year limited warranty*.
- For indoor use. Includes matching wall plate.
- May be used to comply with ASHRAE 62.2, LEED, ENERGY STAR® 3.0 and CALGreen.



Product Specifications	
Ground	Grounding
Feature	Blue LED When On
Amperage	15
Maximum Fan Load	8 Amps
Voltage	120 Volts
Dry Contact Switching	24 Volt AC Input/Output
Terminations	6" Leads
Connections (Copper Wire Connections)	Use #14 or #12
Max Fluorescent Light Load	N/A
Standards and Classifications	UL/CSA Listed
Warranty	2 Year Limited

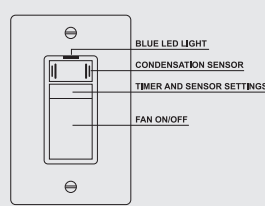

On/Off
FV-WCCS1-W (White)

Timer and Sensor Settings: Minutes Per Hour (MPH) fan timer (left) and Moisture Sensitivity Selector (right), hidden behind a removable cover.

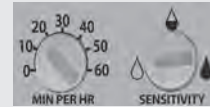

Minutes Per Hour (MPH) Fan Timer:

Runs fan for a selected amount of time every hour, (0-60 mins.) for compliance with ASHRAE 62.2. For example, set to "0", the MPH timer will never turn on. Set to "10", the MPH timer will turn the fan on 10 minutes every hour. Set to "60", the MPH timer will run the fan all the time. The MPH fan timer will also credit any manual use time to the next hours operation (up to 3 hours ahead).

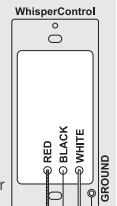

Moisture Sensitivity Selector: Adjusts the unit's sensitivity based on regional climate, size of bathroom and preferred dryness level. Choose from High, Average or Low sensitivity.

Fan ON/OFF: Turns 20-minute countdown timer ON and OFF (can be used to temporarily override the Condensation Sensor Plus).



High Sensitivity - Most sensitive setting, for dryer climates and/or larger rooms.

Average Sensitivity Sensitivity - Condensation Sensor Plus comes factory set to this most common setting.

Low Sensitivity - Least sensitive setting, used in hotter and more humid climates.

* One year additional fan warranty available when a Panasonic WhisperCeilingDC, WhisperValueDC or WhisperFitDC fan is controlled by the Panasonic Condensation Sensor Plus.

FV-WCCS2-W (White)

Condensation Sensor Plus – Fan/Light

- Combination humidity and temperature sensor anticipates dew point, automatically turning the fan on.
- Adjustable Minutes Per Hour fan timer (0-60 mins) for compliance with ASHRAE 62.2.
- Moisture Sensitivity Selector allows fine tuning for dry or moist environments.
- Automatic Fan Control - 30 minute countdown timer initiates after moisture returns to normal levels.
- Manual On/Off Fan Control - 20 minute countdown timer initiates once fan is turned on.
- Manual On/Off Light control.
- Blue LED indicates when the fan is on.
- Commercial Grade - 8 Amp max load, 2 year limited warranty*.
- For indoor use. Includes matching wall plate.
- May be used to comply with ASHRAE 62.2, LEED, ENERGY STAR® 3.0 and CALGreen.



Product Specifications	
Ground	Grounding
Feature	Blue LED When On
Amperage	15
Maximum Fan Load	8 Amps
Voltage	120 Volts
Dry Contact Switching	24 Volt AC Input/Output
Terminations	6" Leads
Connections (Copper Wire Connections)	Use #14 or #12
Max Fluorescent Light Load	400 Watt
Standards and Classifications	UL/CSA Listed
Warranty	2 Year Limited

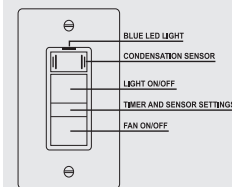

On/Off
FV-WCCS2-W (White)

Timer and Sensor Settings: Minutes Per Hour (MPH) fan timer (left) and Moisture Sensitivity Selector (right), hidden behind a removable cover.

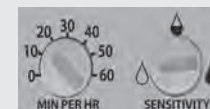

Minutes Per Hour (MPH) Fan Timer:

Runs fan for a selected amount of time every hour, (0-60 mins.) for compliance with ASHRAE 62.2. For example, set to "0", the MPH timer will never turn on. Set to "10", the MPH timer will turn the fan on 10 minutes every hour. Set to "60", the MPH timer will run the fan all the time. The MPH fan timer will also credit any manual use time to the next hours operation (up to 3 hours ahead).

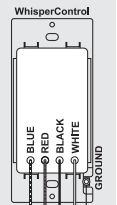

Moisture Sensitivity Selector: Adjusts the unit's sensitivity based on regional climate, size of bathroom and preferred dryness level. Choose from High, Average or Low sensitivity.

Fan ON/OFF: Turns 20-minute countdown timer ON and OFF (can be used to temporarily override the Condensation Sensor Plus).



High Sensitivity - Most sensitive setting, for dryer climates and/or larger rooms.

Average Sensitivity Sensitivity - Condensation Sensor Plus comes factory set to this most common setting.

Low Sensitivity - Least sensitive setting, used in hotter and more humid climates.

* One year additional fan warranty available when a Panasonic WhisperCeilingDC, WhisperValueDC or WhisperFitDC fan is controlled by the Panasonic Condensation Sensor Plus.

For complete Installation Instructions visit

us.panasonic.com/ventfans

Panasonic IAQ Division

Two Riverfront Plaza
Newark, NJ 07102

us.panasonic.com/ventfans

CALGreen



Panasonic

FV-WCD01-W (White)

Preset Countdown and Hourly Timer – Fan Only

- Preset for 5-15-30-45 or 60 minute intervals.
- Adjustable Minutes Per Hour fan timer (0-60 mins) for compliance with ASHRAE 62.2.
- Manual On/Off Fan Control.
- Blue LED indicates when the fan is on.
- Commercial Grade, 8 Amp max load, 2 year limited warranty.
- For indoor use. Includes matching wall plate.
- May be used to comply with ASHRAE 62.2, LEED AND ENERGY STAR® 3.0.



Product Specifications	
Ground	Grounding
Feature	Blue LED When On
Amperage	8 Amp
Voltage	120 Volt
HP Rating	1HP-120V
Termination	6" Leads
Standards & Certifications	UL/CSA Listed
Warranty	2 Year Limited

On/Off
FV-WCD01-W (White)

Timer Settings: Countdown timer (left) and Minutes Per Hour (MPH) fan timer (right), hidden behind a removable cover.

Minutes Per Hour (MPH) Fan Timer:
Runs fan for a selected amount of time every hour, (0-60 mins) for compliance with ASHRAE 62.2. For example, set to "0", the MPH timer will never turn on. Set to "10", the MPH timer will turn the fan on 10 minutes every hour. Set to "60", the MPH timer will run the fan all the time. The MPH fan timer will also credit any manual use time to the next hours operation (up to 3 hours ahead).

Fan ON/OFF: Turns countdown timer ON and OFF (can be used to temporarily override the MPH Timer.)

FV-WCD02-W (White)

Preset Countdown and Hourly Timer - Fan/Light

- Preset for 5-15-30-45 or 60 minute intervals.
- Adjustable Minutes Per Hour fan timer (0-60 mins) for compliance with ASHRAE 62.2.
- Manual On/Off Fan Control.
- Manual On/Off Light Control.
- Blue LED indicates when the fan is on.
- Commercial Grade, 8 Amp max load, 2 year limited warranty.
- For indoor use. Includes matching wall plate.
- May be used to comply with ASHRAE 62.2, LEED AND ENERGY STAR® 3.0.



Product Specifications	
Ground	Grounding
Feature	Blue LED When On
Amperage	8 Amp
Voltage	120 Volt
HP Rating	1HP-120V
Termination	6" Leads
Standards & Certifications	UL/CSA Listed
Warranty	2 Year Limited

On/Off
FV-WCD02-W (White)

Timer Settings: Countdown timer (left) and Minutes Per Hour (MPH) fan timer (right), hidden behind a removable cover.

Minutes Per Hour (MPH) Fan Timer:
Runs fan for a selected amount of time every hour, (0-60 mins) for compliance with ASHRAE 62.2. For example, set to "0", the MPH timer will never turn on. Set to "10", the MPH timer will turn the fan on 10 minutes every hour. Set to "60", the MPH timer will run the fan all the time. The MPH fan timer will also credit any manual use time to the next hours operation (up to 3 hours ahead).

Fan ON/OFF: Turns countdown timer ON and OFF (can be used to temporarily override the MPH Timer.)

For complete Installation Instructions visit
us.panasonic.com/ventfans

Model	Quantity	Comments	Project:
			Location:
			Architect:
			Engineer:
			Contractor:
			Submitted by:
			Date:



PuraFlame 33 Inches Western Electric Fireplace Insert Heater with Fire Crackling Sound, Remote Control, 750/1500W, Black

Electric fireplace insert. 100% energy saving LED technology, realistic flame can be used with or without heat, realistic resin logs and ember bed, down light incre

Three-side brick wall design. High-precision integrated trims going through welding and polishing workmanship makes our products more valuable.

Electronic temperature control which gives more precise temperature makes your room more comfortable.

Remote control can easily operate the fireplace as you want.

750/1500W fan heater. Supplemental heat for up to 400 sq. ft. One year Warranty.

Buy at Amazon



Inquiry Now



Product Description

PuraFlame Western Electric Fireplace insert is energy-saving LED, beautiful and classic fire with slim remote control.

Realistic 4 steps flame effect with variable intensity and brightness can be used with or without heat.

Downlight design in order to increase the brightness of the hearth;

No Gas No Oil needed, and No Smoke damage.

Three-side brick wall design. High-precision integrated trims going through welding and polishing workmanship makes our products more valuable.

Electronic temperature control which gives more precise temperature makes your room more comfortable.

Quiet fence air outlet, 750/1500W fan heater for rooms up to 400 square feet.

Control panel ON/OFF switch must be ON to use remote control.

The Power cord is lengthened to 1.8 meters.

Front fix, easy to use, install and uninstall.

One year Warranty.

Emerson Apartments
11010 NE 124th Lane
Kirkland, WA 98034

HVAC Buildings J, N, U



INSTRUCTIONS TO BIDDERS

1.0 BIDDER RESPONSIBILITY CRITERIA

- A. It is the intent of Owner to award a contract to a responsible bidder submitting the lowest responsive bid. Before award, the bidder must meet the following bidder responsibility criteria to be considered a responsible bidder. The bidder may be required by the Owner to submit documentation demonstrating compliance with the criteria. The bidder must:
1. Have a current certificate of registration as a contractor in compliance with chapter 18.27 RCW, which must have been in effect at the time of bid submittal;
 2. Have a current Washington Unified Business Identifier (UBI) number;
 3. If applicable, have industrial insurance coverage for the bidder's employees working in Washington as required in Title 51 RCW; an employment security department number as required in Title 50 RCW; and a state excise tax registration number as required in Title 82 RCW;
 4. Not be disqualified from bidding on any public works contract under RCW 39.06.010 or 39.12.065(3);
 5. Have received training on the requirements related to public works and prevailing wage under chapter 39.04.350 RCW and chapter 39.12 RCW or be listed as exempt by the department of labor and industries on its website; and
 6. Within the three-year period immediately preceding the date of the bid solicitation, not have been determined by a final and binding citation and notice of assessment issued by the department of labor and industries or through a civil judgment entered by a court of limited or general jurisdiction to have willfully violated, as defined in RCW 49.48.082, any provision of chapter 49.46, 49.48, or 49.52 RCW;
 7. Before award of a public works contract, a bidder shall submit to the contracting agency a signed statement in accordance with RCW 9A.72.085 verifying under penalty of perjury that the bidder is in compliance with the responsible bidder criteria requirement of subsection A, 6 of this section.

1.1 SUBCONTRACTOR RESPONSIBILITY

- A. The Contractor shall include the language of this section in each of its first tier subcontracts, and shall require each of its subcontractors to include the same language of this section in each of their subcontracts, adjusting only as necessary the terms used for the contracting parties. Upon request of the Owner, the Contractor shall promptly provide documentation to the Owner demonstrating that the subcontractor meets the subcontractor responsibility criteria below. The requirements of this section apply to all subcontractors regardless of tier.
- B. At the time of subcontract execution, the Contractor shall verify that each of its first tier subcontractors meets the following bidder responsibility criteria:
1. Have a current certificate of registration in compliance with chapter 18.27 RCW, which must have been in effect at the time of subcontract bid submittal;
 2. Have a current Washington Unified Business Identifier (UBI) number;
 3. If applicable, have:
 - a. Have Industrial Insurance (workers' compensation) coverage for the subcontractor's employees working in Washington, as required in Title 51 RCW;
 - b. A Washington Employment Security Department number, as required in Title 50 RCW;

INSTRUCTIONS TO BIDDERS

- c. A Washington Department of Revenue state excise tax registration number, as required in Title 82 RCW;
 - d. An electrical contractor license, if required by Chapter 19.28 RCW;
 - e. An elevator contractor license, if required by Chapter 70.87 RCW.
4. Not be disqualified from bidding on any public works contract under RCW 39.06.010 or 39.12.065 (3);
 5. Have received training on the requirements related to public works and prevailing wage under chapter 39.04.350 RCW and chapter 39.12 RCW or be listed as exempt by the department of labor and industries on its website; and
 6. Within the three-year period immediately preceding the date of the bid solicitation, not have been determined by a final and binding citation and notice of assessment issued by the department of labor and industries or through a civil judgment entered by a court of limited or general jurisdiction to have willfully violated, as defined in RCW 49.48.082, any provision of chapter 49.46, 49.48, or 49.52 RCW.

1.2 SUPPLEMENTAL BIDDER RESPONSIBILITY CRITERIA

- A. RCW 39.04.350(2) specifically authorizes municipalities to adopt relevant supplement criteria for determining bidder responsibility applicable to a particular project which the bidder must meet.
- B. For the work in this project a responsible/qualified Bidder must meet the following standards:
 1. Have a current certificate of registration as a contractor, in compliance with chapter 18.27 RCW, for the last three years under the same business name;
 2. Have a good record of past performance that includes, but is not limited to, high quality work, ability to complete projects on time, contractor's integrity, compliance with public policy, financial, contractual and tax obligations, as well as Federal and State rules and regulations in performing construction contracts.
 3. Have a current Experience Modification Rate (EMR) of 1.0 or less, or an average EMR rate of 1.0 or less over the last three years. The requirement may, at the Owner's sole discretion, be waived on review of a written explanation that includes details of accidents, L&I records, a Loss Ratio Report for the last five years, costs, dates of events, and changes that have been made by the contractor to reduce accidents. A current company Safety Plan shall also be reviewed.
 4. Bidder shall provide evidence of previous successful completion of fans and fireplace projects of similar scope and complexity. Poor performance, lack of response, or failure to complete projects successfully within the contract time may be grounds for the rejection of bidder.
- C. Subcontractors shall have had three years minimum experience licensed in Washington State in the specific specialty contracting business.

1.3 PREPARATION OF BIDS – CONSTRUCTION

- A. Bids must be submitted on the Bid Form furnished by the Owner.
- B. All fields and questions on required forms must be fully answered and complete. Failure to do so may result in the bid being declared non-responsive.

INSTRUCTIONS TO BIDDERS

- C. Bidders shall acknowledge receipt of all addenda to this solicitation by inserting the addenda numbers in the space provided on the Bid Form. Failure to do so may result in the bid being declared non-responsive.
 - 1. Bidder is responsible for checking KCHA's website for addenda prior to submitting bid.
- D. In order for a bid to be considered responsive, bidders must submit the following signed documents with their bid package:
 - 1. Bid Form
 - 2. Bidder's Information Form
- E. The Bidder agrees to hold the base bid prices for sixty (60) days from date of bid opening.

1.4 AMENDMENTS TO INVITATION TO BID

- A. If this solicitation is amended, then all terms and conditions which are not modified remain unchanged.
- B. Bidders shall acknowledge receipt of all addenda to this solicitation by inserting the addenda numbers in the space provided on the Bid Form. Failure to do so may result in the bid being declared non-responsive.
 - 1. Bidder is responsible for checking KCHA's website for addenda prior to the bid due date.
 - 2. Addenda will not be issued later than three (3) calendar days before the deadline for receipt of Bids except Addendum withdrawing the request for Bids or extending the deadline for receipt of Bids.

1.5 PRE-BID MEETING

- A. All potential bidders are strongly encouraged to attend. Oral statements may not be relied upon and will not be binding or legally effective.

1.6 EXAMINATION OF PLANS, SPECIFICATIONS, AND SITE

- A. Before submitting a bid, the Bidder shall carefully examine each component of the Contract Documents prepared for the Work and any other available supporting data so as to be thoroughly familiar with all the requirements.
- B. The Bidder shall obtain copies of all agencies and associations guidelines and standards cited in the Contract Documents and necessary to perform the Work, including full size reproductions of material provided by Owner, at their own expense.
- C. The Bidder shall make a thorough and reasonable examination of the project site, facility and conditions under which the Work is to be performed, including but not limited to: Building access; resident occupancy; fire lanes; landscaping; obstacles and character of materials which may be encountered; traffic conditions; public and private utilities; the availability and cost of labor; and available facilities for transportation, handling, and storage of materials and equipment.

INSTRUCTIONS TO BIDDERS

1.7 EXPLANATION TO PROSPECTIVE BIDDERS

- A. Any prospective bidder desiring an explanation or interpretation of the solicitation, drawings, specifications, etc., must submit a request in writing to the Owner seven (7) calendar days before the bid due date. Oral explanations or instructions given before the award of a contract will not be binding. Questions shall be submitted to:

Michelle Jackson
King County Housing Authority
600 Andover Park W
Seattle, WA 98188
Email: MichelleJ@kcha.org

1.8 PREVAILING WAGES

- A. Contractor shall pay no less than the Washington State Department of Labor and Industries (L&I) prevailing rate of wages to all workers, laborers, or mechanics employed in the performance of any part of the Work in accordance with RCW 39.12 and the rules and regulations of L&I. The schedule of prevailing wage rates for the locality or localities of the Work is determined by the Industrial Statistician of L&I. It is the Contractor's responsibility to verify the applicable prevailing wage rate.
1. L&I prevailing wage rates may be found at <https://lni.wa.gov/licensing-permits/public-works-projects/prevailing-wage-rates/>
 2. The Owner has determined that the work meets the definition of residential construction.
 3. The prevailing wage rates publication date is determined by the bid due date.
 4. The work is to be performed in King County.
 5. A copy of the prevailing wage rates is available at KCHA.
 6. A copy of the prevailing wage rates may be mailed on request.

1.9 TAXES

- A. All taxes imposed by law shall be included in the bid amount. The Contractor shall pay the WSST to the Department of Revenue and shall furnish proof of payment to the Owner if requested.
- B. The retail sales tax does not apply to the gross contract price as indicated in WAC 458-20-17001.
- C. Prime and subcontractors are required to pay retail sales tax upon all purchases of materials, including prefabricated and precast items, equipment, leases or rentals of tools, consumables, and other tangible personal property which is installed, applied, attached, or otherwise incorporated in their work.

1.10 ASSURANCE OF COMPLETION

- A. Payment and performance bonds for 100% of the Contract Sum, including all Change Orders and taxes imposed by law, shall be furnished for the Work, and shall be in a form acceptable to the Owner.

INSTRUCTIONS TO BIDDERS

1. On contracts of one hundred fifty thousand dollars (\$150,000.00) or less, the requirement for a Performance and Payment Bond may, at Contractors option, be waived in lieu of an additional 5% (total 10%) retainage.

1.11 BID ERROR

- A. In the event Bidder discovers an error in its bid, the Bidder may, under certain conditions and if before the date and time that bids are due, modify, their bid, as detailed below:

1. Prior to Date and Time Bids are Due:

- a. A Bidder may withdraw its bid at any time prior to the date and time bids are due upon written request.
- b. After withdrawing an original submitted bid, a Bidder may modify and resubmit its bid at any time prior to the date and time bids are due.

2. After the Date and Time Bids are Due:

- a. A bidder who submits an erroneous low bid may withdraw the bid. The bid withdrawal is permissible if there was an obvious error in the low bid, and the mistake is readily apparent from the bid itself.
- b. Notification: Provide to the Owner, within 24 hours of bid opening, written notification of the bidder's intent to withdraw the bid due to error.
- c. Documentation: Provide to the Owner within 48 hours of bid opening, documentation sufficient in content to justify bid withdrawal to the satisfaction of the Owner. Include description and evidence of the error.
- d. Approval: the Owner will approve or reject the request for withdrawal in writing.
- e. Any low bidder who withdraws its bid is prohibited from bidding on the same project if it is subsequently re-solicited.

1.12 ADDITIVE OR DEDUCTIVE BID ITEMS

- A. The low bid, for purposes of award, shall be the lowest responsive bid from a qualified responsible bidder offering the low aggregate amount for the base bid, plus additive or deductive bid alternates selected by the Owner.

1.13 BID EVALUATION

- A. Responsive Bids: A bid will be considered responsive if it meets the conditions of the solicitation, in addition to but not limited to the following requirements:

1. Bid is received not later than the time and date specified.
2. Bid is submitted in the proper format on the form(s) provided.
3. Bid includes the complete scope of work as defined in bid package.
4. Bid does not include any exclusions or qualifications.
5. Bid includes Unit and Lump Sum Costs as listed in Proposal Form.
6. Forms are complete.

- B. After bid opening, bids will be checked for correctness of bid item price extensions and the total bid price. A discrepancy between a bid item price and the extended amount of any bid item shall be resolved by accepting the bid item price as correct.

INSTRUCTIONS TO BIDDERS

- C. Responsible Bidders: the Owner will award contracts only to responsible bidders who demonstrate the ability to successfully perform under the terms and conditions as set forth in the Contract Documents and have successfully completed projects similar in scope and complexity.
 - 1. Bidders must demonstrate relevant experience on similar types of projects and submit detailed information as required on the Bidder Information Form.
- D. The Owner reserves the right to contact references and investigate past performance and qualifications of the Bidder, subcontractor, and project team members, including contacting third parties and/or the references provided by the Bidder.
 - 1. The Owner may contact references for other projects including those the Bidder did not identify and/or provided references.
 - 2. References may be asked to rate the performance of and describe their experience with project team members and subcontractors. Bidder Information may be solicited and evaluated on the following subjects: type and features of work; overall quality of project performance and quality of work; experience and technical knowledge and competence of the Bidder and Project Team Members; ability, capacity and skill to perform the Work; ability to manage submittals, requests for information, prevailing wage filings, and other paperwork; compliance with laws, ordinances, and contract provisions; and other information as deemed necessary.
 - 3. Poor reference(s) may be justification to determine a Bidder is not responsible.
- E. At the Owner's request, provide any additional explanation or information, which would assist in evaluating the qualifications of the Bidder, subcontractors, project team members, and bid price.
- F. The Owner will verify information submitted and if the lowest bidder is determined to be “not responsible,” the Owner will issue, in writing, the specific reasons for this determination. The bidder may appeal this decision. The appeal must be in writing and shall be delivered to the Owner within two business days. The appeal may include additional information that was not included in the original bid documents. KCHA will make a final determination after the receipt of the appeal. The final determination may not be appealed.

1.14 CONTRACT AWARD

- A. Bonding and Insurance: Contract award will be contingent on ability to secure payment/performance bonding, and Contractor’s ability to meet the Owner insurance requirements as detailed in the Bid Documents.
- B. Bonding, insurance certificates and endorsements, and an approved Statement of Intent to Pay Prevailing Wages shall be submitted to the Owner within 14 days of award. A Notice to Proceed shall be issued immediately after receipt.
- C. Right to Reject Bids/Waiver: The Owner reserves the right to reject any or all bids or to waive any informalities or irregularities in the bidding.
- D. Retainage Funds: The Owner will not pay interest to the Contractor for accounts where retainage funds are maintained by the Owner. As part of the procurement by which the Contractor was selected for this work, the Contractor agrees to waive any other options and has made allowances for this waiver.

GENERAL CONDITIONS

PART 1 - GENERAL PROVISIONS

1.1 DEFINITIONS

- A. "Authority Having Jurisdiction (AHJ)": A federal, state, local, or other regional department, or an individual such as a fire official, labor department, health department, building official, or other individual having statutory authority.
- B. "Contract Documents" means the Instructions to Bidders, Specifications, Plans, General Conditions, Prevailing Wage Rates, Bid Form, Contract Form, other Special Forms, Drawings and Specifications, and all Addenda and modifications thereof.
- C. "Contract Sum" is the total amount payable by Owner to Contractor for performance of the Work in accordance with the Contract Documents.
- D. "Contract Time" is the number of consecutive Days allotted in the Contract Documents for achieving completion of the Work.
- E. "Contracting Officer" means the person delegated the authority by King County Housing Authority to enter into, and/or terminate this Contract. The term includes any successor Contracting Officer and any duly authorized representative of the Contracting Officer.
- F. "Contractor" means the person or other entity entering into the Contract with King County Housing Authority to perform all of the services or work required under the Contract.
- G. "Day" means calendar day, unless otherwise specified.
- H. "Final Acceptance" means the acceptance by Owner that the Contractor has completed the requirements of the Contract Documents.
- I. "Force Majeure" means those acts entitling Contractor to request an equitable adjustment in the Contract Time, including, but not limited to, unusually severe weather conditions which could not have been reasonably anticipated.
- J. "Furnish": Supply and deliver to Project site, ready for unloading, unpacking, assembly, installation, and similar operations.
- K. "Install": Operations at Project site including unloading, temporarily storing, unpacking, assembling, erecting, placing, anchoring, applying, working to dimension, finishing, curing, protecting, cleaning, and similar operations.
- L. "Liquidated Damages" means the amount prescribed in the Contract Documents to be deducted from any payments due or to become due Contractor, for each day's delay in completion of the Work beyond the time allowed in the Contract Documents as stated in the Notice to Proceed, plus any extensions of such time.
- M. "Manager" means the person who is an authorized agent of the King County Housing Authority to administer the Contract.
- N. "Notice to Proceed" means a notice from Owner to Contractor that defines the date on which the Contract Time begins to run.
- O. "Owner" means the King County Housing Authority or its authorized representative with the authority to enter into, administer, and/or terminate the Work in accordance with the Contract Documents and make related determinations and findings.
- P. "Property Manager" means the property management company, its officers and employees.
- Q. "Provide": Furnish and install, complete and ready for the intended use.

GENERAL CONDITIONS

- R. "Subcontract" means any contract, purchase order, or other purchase agreement, including modifications and change orders to the foregoing, entered into by a Subcontractor to furnish supplies, materials, equipment, and services for the performance of the prime Contract or a subcontract.
- S. "Subcontractor" means any supplier, vendor, or firm that furnishes supplies, materials, equipment, or services to or for the Contractor or another Subcontractor.
- T. "Work" means the construction and services required by the Contract Documents, and includes, but is not limited to, labor, materials, supplies, equipment, services, permits, and the manufacture and fabrication of components, performed, furnished, or provided in accordance with the Contract Documents.

1.2 EXECUTION AND INTENT

- A. The intent of the Specifications and Drawings is to describe a complete Project to be constructed in accordance with the Contract Documents. Contractor shall furnish all labor, materials, equipment, tools, transportation, permits, and supplies, and perform the Work required in accordance with the Contract Documents.
- B. All work is to be executed in accordance with the Building Codes, as adopted by the Authority Having Jurisdiction, and other applicable codes and generally accepted industry standards. All products and materials are to be new and handled and applied in accordance with the manufacturer's recommendations.
- C. Contractor makes the following representations to Owner:
 - 1. The Contract Sum is reasonable compensation for the Work and the Contract Time is adequate for the performance of the Work, as represented by the Contract Documents;
 - 2. Contractor has carefully reviewed the Contract Documents, had an opportunity to visit and examine the Project site, has become familiar with the local conditions in which the Work is to be performed, and has satisfied itself as to the nature, location, character, quality and quantity of the Work, the labor, materials, equipment, goods, supplies, work, permits, services and other items to be furnished and all other requirements of the Contract Documents, as well as the surface and subsurface conditions and other matters that may be encountered at the Project site or affect performance of the Work or the cost or difficulty thereof.
- D. The Contract Documents are complementary. What is required by one part of the Contract Documents shall be binding as if required by all. Anything mentioned in the Specifications and not shown on the Drawings, or shown on the Drawings and not mentioned in the Specifications, shall be of like effect as if shown or mentioned in both.

PART 2 - INSURANCE AND BONDS

2.1 INSURANCE REQUIREMENTS FOR BUILDING TRADES CONTRACTORS

- A. Contractor shall procure and maintain for the duration of the contract insurance against claims for injuries to persons or damages to property that may arise from or in connection with the performance of the work hereunder by the Contractor, his agents, representatives, employees or Subcontractors.

2.2 MINIMUM SCOPE OF INSURANCE

- A. Contractors shall maintain coverages no less than:
 - 1. Insurance Services Office Commercial General Liability coverage including Products/Completed Operations.
 - 2. Insurance Services Office covering Automobile Liability, code 1 (any auto).
 - 3. Workers' Compensation insurance as required by State law and Employer's Liability Insurance.

GENERAL CONDITIONS

2.3 MINIMUM LIMITS OF INSURANCE

A. Contractor shall maintain limits no less than:

1. General Liability: \$1,000,000 per occurrence for bodily injury, personal injury and property damage. If Commercial General Liability Insurance or other form with a general aggregate limit is used, either the general aggregate limit shall apply separately to this project/location or the general aggregate limit of \$2,000,000.
2. Automobile Liability: \$1,000,000 per accident for bodily injury and property damage.
Employer's Liability: \$1,000,000 per accident for bodily injury/sickness or disease.

2.4 DEDUCTIBLES AND SELF INSURED RETENTION

- ### A.
- Any deductibles or self-insured retentions must be declared to and approved by the Owner. At the option of the Owner, either: the insurer shall reduce or eliminate such deductibles or self-insured retentions as respects the Owner, its officers, officials, employees and volunteers; or the Contractor shall provide a financial guarantee satisfactory to the Owner guaranteeing payment of losses and related investigations, claim administration and defense expenses. **NOTE: If this contract deals with hazardous materials or activities (i.e. lead based paint, asbestos, armed security guards) additional provisions covering those exposures must be included in order to protect the Owner's interests.**

2.5 OTHER INSURANCE PROVISIONS

A. The policies are to contain, or be endorsed to contain, the following provisions:

1. The Owner, the Property Manager, its officers, officials, employees, partners, agents and volunteers are to be covered as additional insureds under a "completed operations" type of additional insured endorsement with respect to general liability arising out of work or operations performed by or on behalf of the Contractor including materials, parts or equipment furnished in connection with such work or operations. The endorsement(s) effectuating the foregoing additional insured coverage shall be ISO form CG 20 10 11 85, or CG 20 10 10 01 issued concurrently with CG 20 37 10 01, or their equivalent as long as it provides additional insured coverage, without limitation, for completed operations; (ii) automobile liability arising out of vehicles owned, leased, hired, or borrowed by or on behalf of the Contractor; (iii) any insurance written on a claims made basis, shall have a retroactive date that coincides with, or precede, the commencement of any work under this contract. Evidence of such coverage shall be maintained for a minimum of six (6) years beyond the expiration of the project.
2. King County will not accept Certificates of Insurance Alone. Improperly Completed Endorsements will be returned to your insured for correction by an authorized representative of the insurance company.
3. For any claims related to this project, the Contractor's insurance coverage shall be primary insurance as respects the Owner, its officers, officials, agents, partners, employees, and volunteers. Any insurance or self-insurance maintained or expired by the Owner, its officers, officials, agents, partners, employees, volunteers, or shall be excess of the Contractor's insurance and shall not contribute with it. King County Housing Authority's Insurance is Non-Contributory in Claims Settlement Funding.
4. The "General description of agreement(s) and/or activity(s) insured" shall include reference to the activity and/or to either specific King County Housing Authority's; project of site name, contract number, lease number, permit number or construction approval number.
5. Each insurance policy required by this clause shall be endorsed to state that coverage shall not be canceled or materially changed, except after thirty (30) days' [ten (10) days for non-payment of premium] prior written notice by certified mail, return receipt requested, has been given to the Owner.
6. Maintenance of the proper insurance for the duration of the contract is a material element of the contract. Material changes in the required coverage or cancellation of the coverage shall constitute a material breach of the contract.

2.6 ACCEPTABILITY OF INSURERS

- ### A.
- Insurance is to be placed with insurers with a current A.M. Best's rating of no less than A-:VII. The name of the Insurance Company underwriting the coverage and its address shall be noted on the endorsement form. Contractors must provide written verification of their insurer's rating.

GENERAL CONDITIONS

2.7 VERIFICATION OF COVERAGE

- A. Contractor shall furnish the Owner with original certificates and amendatory endorsements effecting coverage required by this clause. All certificates and endorsements are to be received and approved by the Owner before work commences in sufficient time to permit contractor to remedy any deficiencies. The Owner reserves the right to require complete, certified copies of all required insurance policies or pertinent parts thereof, including endorsements affecting the coverage required by these specifications at any time.

2.8 SUBCONTRACTORS

- A. Subcontractors shall include the Contractor as additional insured under their policies. All coverage's for subcontractors shall be subject to all of the requirements stated herein. Contractor shall be responsible for the adequacy of required coverages for subcontractors, and compile related certificates of insurance and endorsements evidencing subcontractors' compliance.

2.9 PAYMENT AND PERFORMANCE BONDS

- A. Payment and performance bonds for 100% of the Contract Award Amount shall be furnished for the Work, using the Payment Bond and Performance Bond form AIA – form A312. Change order increases of cumulative 15% increments require revisions to the bond to match the new Contract Sum.
- B. On contracts of one hundred fifty thousand dollars or less, at the option of the contractor as defined in RCW 39.10.210, the Owner may, in lieu of the bond, retain ten percent of the contract amount for a period of forty-five days after date of final acceptance, or until receipt of all necessary releases from the department of revenue, the employment security department, and the department of labor and industries and settlement of any liens filed under chapter 60.28 RCW, whichever is later.

PART 3 - PERFORMANCE

3.1 CONTRACTOR CONTROL AND SUPERVISION

- A. Contractor shall be solely responsible for, and have control over construction means, methods, techniques, sequences, and procedures and for coordinating all portions of the Work, and shall be responsible to Owner for acts and omissions of Contractor, Subcontractors, and their employees and agents.
- B. Contractor shall enforce strict discipline and good order among Contractor's employees and other persons performing the Work. Contractor shall not permit employment of persons not skilled in tasks assigned to them. Owner may, by Notice, request Contractor to remove from the Work or Project site any employee Owner reasonably deems incompetent, careless, or otherwise objectionable.
- C. The Contractor shall perform on the site, and with its own organization, work equivalent to at least 12% of the total amount of work to be performed under the contract.
- D. Work Hours: The Contractor's allowable hours of operation shall be limited to those hours between 8:00 A.M. and 6:00 P.M. Monday to Friday excluding public holidays.

3.2 PERMITS, FEES, AND NOTICES

- A. Unless otherwise provided in the Contract Documents, Contractor shall pay for and obtain all permits, licenses, and coordinate inspections necessary for proper execution and completion of the Work. Prior to final payment, the approved, signed permits shall be delivered to Owner.

3.3 PREVAILING WAGES

- A. Statutes of the State of Washington RCW 39.12 as amended shall apply to this contract. Requirements, in brief, are stated below:

GENERAL CONDITIONS

1. There shall be paid each laborer or mechanic of the Contractor or sub-Contractor engaged in work on the project under this contract in the trade or occupation listed in the schedule of Wage Rates, as determined by the Department of Labor and Industries, not less than the hourly wage rate listed therein, regardless of any contractual relationship which may be alleged to exist between the Contractor and any sub-contractor and such laborers and mechanics.
2. The "prevailing rate or wage" contained in the wage determination include health and welfare fund contributions and other fringe benefits collectively bargained for by the various management and labor organizations. Prevailing wages shall be paid based on the most recent semi-annual list as required by the Department of Labor and Industries (L&I).
3. In case any dispute arises as to what are the prevailing rates for wages of work of a similar nature, and such disputes cannot be resolved by the parties involved, including labor and management representatives, the matter shall be referred for arbitration to the Director of the Department of Labor and Industries of the State of Washington, and the Director's decision shall be final and conclusive and binding on all parties involved in the dispute.

B. Before commencing the Work, Contractor shall file a statement of "Intent to Pay Prevailing Wages."

C. After completion of the Work, Contractor shall file an "Affidavit of Wages Paid."

3.4 EQUAL EMPLOYMENT OPPORTUNITY

A. During performance of the Work:

1. Contractor shall not discriminate against any employee or applicant for employment because of race, creed, color, national origin, sex, age, marital status, the presence of any physical, sensory, or mental disability, sexual orientation, Vietnam-era veteran status, disabled veteran status or political affiliation, nor commit any unfair practices as defined in RCW 49.60.
2. The Contractor shall take affirmative action to ensure that applicants are employed, and that employees are treated during employment without regard to their race, color, religion, sex, national origin, of any physical, sensory, or mental disability, sexual orientation, Vietnam-era veteran status, disabled veteran status, or political affiliation.
3. The Contractor shall give all notices and comply with all applicable laws, ordinances, rules, regulations and orders in regard to Equal Employment Opportunity including but not limited to Executive Order 11246, as amended, Section 503 of the Rehabilitation Act of 1973, as amended, and the rules, regulations, and orders of the Secretary of Labor. The Contractor shall include the terms of this Clause in every subcontract so that such term shall be binding on each Subcontractor.
4. Non-Discrimination R.C.W. 49.60: These special requirements establish minimum requirements for affirmative action and are intended to define and implement the basic discrimination provisions of these specifications. Failure to comply with these requirements may constitute grounds for application of contract default.

3.5 SAFETY PRECAUTIONS

A. In performing this contract, the Contractor shall provide for protecting the lives and health of employees and other persons; preventing damage to property, materials, supplies, and equipment; and avoid work interruptions. For these purposes, the Contractor shall:

1. Follow Washington Industrial Safety and Health Act (WISHA) regional directives and provide a site-specific safety program that will require an accident prevention and hazard analysis plan for the contractor and each subcontractor on the work site. The Contractor shall submit a site-specific safety plan to the Owner's representative prior to the initial scheduled construction meeting.
2. Provide adequate safety devices and measures including, but not limited to, the appropriate safety literature, notice, training, permits, placement and use of barricades, signs, signal lights, ladders, scaffolding, staging, runways, hoist, construction elevators, shoring, temporary lighting, grounded outlets, wiring, hazardous materials, vehicles, construction processes, and equipment required by Chapter 19.27 RCW, State Building Code (Uniform Building, Electrical, Mechanical, Fire, and Plumbing Codes); Chapter 212-12 WAC, Fire Marshal Standards, Chapter 49.17 RCW, WISHA; Chapter 296-155 WAC, Safety Standards for Construction Work; Chapter 296-65 WAC; WISHA Asbestos Standard; WAC 296-62-071, Respirator Standard; WAC 296-62, General Occupation Health Standards, WAC 296-24, General Safety and Health Standards, WAC 296-24, General Safety and Health Standards, Chapter 49.70 RCW, and Right to Know Act.

GENERAL CONDITIONS

3. Comply with the State Environmental Policy Act (SEPA), Clean Air Act, Shoreline Management Act, and other applicable federal, state, and local statutes and regulations dealing with the prevention of environmental pollution and the preservation of public natural resources.
 4. Post all permits, notices, and/or approvals in a conspicuous location at the construction site.
 5. Provide any additional measures that the Owner determines to be reasonable and necessary for ensuring a safe environment in areas open to the public. Nothing in this part shall be construed as imposing a duty upon the Owner to prescribe safety conditions relating to employees, public, or agents of the Contractors.
- B. Contractor to maintain safety records: Contractor shall maintain an accurate record of exposure data on all incidents relating to the Work resulting in death, traumatic injury, occupational disease, or damage to property, materials, supplies, or equipment. Contractor shall immediately report any such incident to Owner. Owner shall, at all times, have a right of access to all records of exposure.
- C. Contractor to provide HazMat training: Contractor shall provide all persons working on the Project site with information and training on hazardous chemicals in their work at the time of their initial assignment, and whenever a new hazard is introduced into their work area.
1. Information. At a minimum, Contractor shall inform persons working on the Project site of:
 - a. WAC: The requirements of chapter 296-62 WAC, General Occupational Health Standards;
 - b. Presence of hazardous chemicals: Any operations in their work area where hazardous chemicals are present; and
 - c. Hazard communications program: The location and availability of written hazard communication programs, including the required list(s) of hazardous chemicals and material safety data sheets required by chapter 296-62 WAC.
 2. Training. At a minimum, Contractor shall provide training for persons working on the Project site which includes:
 - a. Detecting hazardous chemicals: Methods and observations that may be used to detect the presence or release of a hazardous chemical in the work area (such as monitoring conducted by the employer, continuous monitoring devices, visual appearance or odor of hazardous chemicals when being released, etc.);
 - b. Hazards of chemicals: The physical and health hazards of the chemicals in the work area;
 - c. Protection from hazards: The measures such persons can take to protect themselves from these hazards, including specific procedures Contractor, or its Subcontractors, or others have implemented to protect those on the Project site from exposure to hazardous chemicals, such as appropriate work practices, emergency procedures, and personal protective equipment to be used; and
 - d. Hazard communications program: The details of the hazard communications program developed by Contractor, or its Subcontractors, including an explanation of the labeling system and the material safety data sheet, and how employees can obtain and use the appropriate hazard information.
- D. Hazardous, toxic or harmful substances: Contractor's responsibility for hazardous, toxic, or harmful substances shall include the following duties:
1. Illegal use of dangerous substances: Contractor shall not keep, use, dispose, transport, generate, or sell on or about the Project site, any substances now or hereafter designated as, or which are subject to regulation as, hazardous, toxic, dangerous, or harmful by any federal, state or local law, regulation, statute or ordinance (hereinafter collectively referred to as "hazardous substances"), in violation of any such law, regulation, statute, or ordinance, but in no case shall any such hazardous substance be stored on the Project site.
 2. Contractor notifications of spills, failures, inspections, and fines: Contractor shall promptly notify Owner of all spills or releases of any hazardous substances which are otherwise required to be reported to any regulatory agency and pay the cost of cleanup. Contractor shall promptly notify Owner of all failures to comply with any federal, state, or local law, regulation, or ordinance; all inspections of the Project site by any regulatory entity concerning the same; all regulatory orders or fines; and all responses or interim cleanup actions taken by or proposed to be taken by any government entity or private party on the Project site.

GENERAL CONDITIONS

- E. Public safety and traffic: All Work shall be performed with due regard for the safety of the public. Contractor shall perform the Work so as to cause a minimum of interruption of vehicular traffic or inconvenience to pedestrians. All arrangements to care for such traffic shall be Contractor's responsibilities. All expenses involved in the maintenance of traffic by way of detours shall be borne by Contractor.
- F. Contractor to act in an emergency: In an emergency affecting the safety of life or the Work or of adjoining property, Contractor is permitted to act, at its discretion, to prevent such threatened loss or injury, and Contractor shall so act if so authorized or instructed.
- G. No duty of safety by Owner: Nothing provided in this section shall be construed as imposing any duty upon Owner with regard to, or as constituting any express or implied assumption of control or responsibility over, Project site safety, or over any other safety conditions relating to employees or agents of Contractor or any of its Subcontractors, or the public.

3.6 INDEPENDENT CONTRACTOR

- A. The Contractor and Owner agree the Contractor is an independent contractor with respect to the services provided pursuant to this Contract. Nothing in this Contract shall be considered to create a relationship of employer and employee between the parties hereto. Neither the Contractor nor any employee of the Contractor shall be entitled to any benefits accorded Owner employees by virtue of the services provided under this Contract. The Owner shall not be responsible for withholding or otherwise deducting federal income tax or social security or contributing to the State Industrial Insurance Program, or otherwise assuming the duties of an employer with respect to the Contractor, or any employees of the Contractor.

3.7 OPERATIONS, MATERIAL HANDLING, AND STORAGE AREAS

- A. Contractor shall confine all operations, including storage of materials, to Owner-approved areas.
- B. Contractor shall be responsible for the proper care and protection of its materials and equipment delivered to the Project site.
- C. Contractor shall protect and be responsible for any damage or loss to the Work, or to the materials or equipment until the date of Final Acceptance, and shall repair or replace without cost to Owner any damage or loss that may occur.

3.8 PRIOR NOTICE OF EXCAVATION

- A. Prior to any excavation Contractor shall engage a locate service for all underground facilities or utilities. Contractor shall pay all fees for locator services and pay for all damages caused by excavation.

3.9 UNFORESEEN PHYSICAL CONDITIONS

- A. Notice requirement for concealed or unknown conditions: If Contractor encounters conditions at the site which are subsurface or otherwise concealed physical conditions which differ materially from those indicated in the Contract Documents, or unknown physical conditions of an unusual nature which differ materially from those ordinarily found to exist and generally recognized as inherent in construction activities of the character provided for in the Contract Documents, then Contractor shall give written notice to Owner promptly and in no event later than seven Days after the first observance of the conditions. Conditions shall not be disturbed prior to such notice.
- B. Adjustment in Contract Time and Contract Sum: If such conditions differ materially and cause a change in Contractor's cost of, or time required for, performance of any part of the Work, the Contractor may be entitled to an equitable adjustment in the Contract Time or Contract Sum, or both, provided it makes a request therefore as provided in Part 5.

3.10 PROTECTION OF EXISTING STRUCTURES, EQUIPMENT, VEGETATION, UTILITIES, AND IMPROVEMENTS

GENERAL CONDITIONS

- A. Contractor shall protect from damage all existing conditions, including soils, structures, equipment, improvements, utilities, and vegetation at or near the Project site; and on adjacent property of a third party, the locations of which are made known to or should be known by Contractor. Contractor shall repair any damage, including that to the property of a third party, resulting from failure to comply with the requirements of the Contract Documents, any defects of equipment, material, workmanship or design furnished by the Contractor, or failure by Contractor or subcontractor at any tier to exercise reasonable care in performing the Work. If Contractor fails or refuses to repair the damage promptly, Owner may have the necessary work performed and charge the cost to Contractor.
- B. New work which connects to existing work shall correspond in all respects with that to which it connects and/or be similar to existing work unless otherwise required by the Specifications.

3.11 MATERIAL AND EQUIPMENT

- A. All equipment, material, and articles incorporated into the Work shall be new and of the most suitable grade for the purpose intended, unless otherwise specifically provided in the Contract Documents. References in the Specifications to equipment, material, articles, or patented processes by trade name, make, or catalog number, shall be regarded as establishing a standard quality and shall not be construed as limiting competition. Contractor may, at its option, use any equipment, material, article, or process that, in the judgment of Owner, is equal to that named in the Specifications, unless otherwise specifically provided in the Contract Documents.
- B. Substitutions shall be considered where qualities and attributes including, but not limited to, cost, performance, weight, size, durability, visual effect, and specific features and requirements indicated are deemed equal or better by the Owner at the Owner's sole discretion. All requests for substitutions shall be made in writing to Owner and shall not be deemed to be approved unless approved in writing by Owner.

3.12 CORRECTION OF NONCONFORMING WORK

- A. Contractor shall promptly correct Work found by Owner not to conform to the requirements of the Contract Documents, whether observed before or after Final Acceptance.
- B. If Contractor fails to correct nonconforming Work, Owner may replace, correct, or remove the nonconforming Work and charge the cost thereof to the Contractor.

3.13 CLEAN UP

- A. Contractor shall at all times keep the Project site, including hauling routes, infrastructures, utilities, and storage areas, free from accumulations of waste materials. Before completing the Work, Contractor shall remove from the premises its rubbish, tools, scaffolding, equipment, and materials. Upon completing the Work, Contractor shall leave the Project site in a clean, neat, and orderly condition satisfactory to Owner. If Contractor fails to clean up as provided herein, and after reasonable notice from Owner, Owner may do so and the cost thereof shall be charged to Contractor.

3.14 SUBCONTRACTORS AND SUPPLIERS

- A. Contractor shall utilize Subcontractors and suppliers which are experienced and qualified.
- B. By appropriate written agreement, Contractor shall require each Subcontractor to be bound to Contractor by terms of those Contract Documents, and to assume toward Contractor all the obligations and responsibilities which Contractor assumes toward Owner in accordance with the Contract Documents. Each Subcontract shall preserve and protect the rights of Owner in accordance with the Contract Documents with respect to the Work to be performed by the Subcontractor so that subcontracting thereof will not prejudice such rights. Contractor shall require each Subcontractor to enter into similar agreements with Sub-subcontractors. However, nothing in this paragraph shall be construed to alter the contractual relations between Contractor and its Subcontractors with respect to insurance or bonds.
- C. Contractor shall schedule, supervise, and coordinate the operations of all Subcontractors. No Subcontracting of any of the Work shall relieve Contractor from its responsibility for the performance of the Work in accordance with the Contract Documents or any other obligations of the Contract Documents.

GENERAL CONDITIONS

- D. It is the Contractor's responsibility to pay its Subcontractors and material suppliers on a timely basis. The Owner reserves the right to withhold a portion of the Contractor's payment if the Contractor fails to make timely payments to the Subcontractors and material suppliers.
- E. The Contract Documents shall not be construed to create a contractual relationship of any kind between the Owner and any Subcontractor; or any persons other than Owner and Contractor.
- F. The Contractor shall not enter into any subcontract with any subcontractor who has been suspended or debarred from participating in contracting programs by any agency of the United States Government or by any state, territory, or municipality.

3.15 INDEMNIFICATION

- A. The Contractor hereby agrees to indemnify, defend, and hold harmless the Authority, its successors and assigns, director, officers, officials, employees, agents, partners and volunteers (all foregoing singly and collectively (Indemnities")) from a and against any and all claims, losses, harm costs, liabilities, damages and expenses, including, but not limited to, reasonable attorney's fees arising or resulting from the performance of the services, or the acts or omissions of the Contractor its successors, and assigns, employees, subcontractors or anyone acting on the contractor's behalf in connection with this Contract or its performance of this Contract.
- B. Provided, however, that the Contractor will not be required to indemnify, defend, or save harmless the indemnitee as provided in the preceding paragraphs of this section if the claim, suit, or action for injuries, death, or damages is caused by the sole negligence of the indemnitee. Where such claims, suites, or actions result from the concurrent negligence of (a) the indemnitee or the indemnitee's agents or employees and (b) the Contractor or the Contractor's agent or employee, the indemnity provisions provided in the proceeding paragraphs of this section shall be valid and enforceable only to the extent of the Contractor's negligence or the negligence of its agents and employees..
- C. The foregoing indemnity is specifically and expressly intended to constitute a waiver of the Contractor's immunity under Washington's Industrial Insurance act, RCW Title 51. The parties acknowledge that these provisions were specifically negotiated and agreed upon by them. If any portion of this indemnity clause is invalid or unenforceable, it shall be deemed excised and the remaining portions of the clause shall be given full force and effect.
- D. The Contractor hereby agrees to require all its Subcontractors or anyone acting under its direction or control or on its behalf in connection with or incidental to the performance of this Contract to execute an indemnity clause identical to the preceding clause, specifically naming the Owner as indemnity, and failure to do so shall constitute a material breach of this Contract by the Contractor.

3.16 PROHIBITION AGAINST LIENS

- A. The Contractor is prohibited from placing a lien on the Owner's property. This prohibition shall apply to all subcontractors of any tier and all materials suppliers, in accordance with RCW 35.82.190.

3.17 DAMAGES FOR FAILURE TO ACHIEVE TIMELY COMPLETION

- A. Liquidated Damages
 - 1. Timely performance and completion of the Work is essential to Owner and time limits stated in the Contract Documents are of the essence. The liquidated damage amounts set forth will be assessed not as a penalty, but as liquidated damages for breach of the Contract Documents. This amount is fixed and agreed upon by and between the Contractor and Owner because of the impracticability and extreme difficulty of fixing and ascertaining the actual damages the Owner would in such event sustain. This amount shall be construed as the actual amount of damages sustained by the Owner, and may be retained by the Owner and deducted from any payments to the Contractor.
 - 2. If different completion dates are specified in the contract for separate parts or stages of the work, the amount of liquidated damages shall be assessed on those parts or stages which are delayed.

GENERAL CONDITIONS

3.18 WAIVER AND SEVERABILITY

- A. The failure or delay of either party to insist on performance of any provision of the Contract, or to exercise any right or remedy available under the Contract, shall not be construed as a waiver of that provision, right, or remedy in any later instance. Waiver or breach of any provision of the Contract shall not be construed to be a waiver of any other or subsequent breach and shall not be construed to be a modification of the terms of the Contract, unless the Contract is modified pursuant to the Clause entitled "Contract Modifications" herein.
- B. If any provision of the Contract is or becomes void or unenforceable by operation of law, the remaining provisions shall be valid and enforceable.

PART 4 - PAYMENTS AND COMPLETION

4.1 CONTRACT SUM

- A. The Contract Sum shall include all taxes imposed by law and properly chargeable to the Project, including sales tax. The Contractor shall pay the WSST to the Department of Revenue and shall furnish proof of payment to the Owner if requested.
- B. The retail sales tax does not apply to the gross contract price.
- C. Prime and subcontractors are required to pay retail sales tax upon all purchases of materials, including prefabricated and precast items, equipment, leases or rentals of tools, consumables, and other tangible personal property which is installed, applied, attached, or otherwise incorporated in their work.

4.2 APPLICATION FOR PAYMENT

- A. At monthly intervals, unless determined otherwise by Owner, Contractor shall submit to Owner an Application for Payment for Work completed in accordance with the Contract Documents. Each application shall be supported by such substantiating data as Owner may require.
- B. Each invoice shall include the following statement: "I hereby certify that the items listed are proper charges for materials, merchandise or services provided to the King County Housing Authority, and that all goods and/or services have been provided; that prevailing wages have been paid in accordance with the approved statements of intent filed with the Department of Labor and Industries; and that sub-contractors and/or suppliers have been paid, less earned retainage, as their interest appears in the last payment received."
- C. Coordinate preparation of the Schedule of Values with preparation of Contractor's Construction Schedule. Each Application for Payment shall be consistent with previous applications and payments.
- D. Owner shall retain 5% of the amount of each progress payment until 45 Days after Final Acceptance and receipt of all documents required by law or the Contract Documents including releases by Washington State Employment Security Department and Washington State Department of Revenue and Department of Labor & Industries.
- E. Waivers of Lien: With each Application for Payment, submit conditional waivers lien from every entity who is lawfully entitled to file a lien arising out of the Contract and related to the Work covered by the payment.
 - 1. Submit partial waivers on each item for amount requested, before deduction for retainage, on each item.
 - 2. When an application shows completion of an item, submit final or full waivers.
 - 3. Owner reserves the right to designate which entities involved in the Work must submit waivers.
 - a. Submit final Application for Payment with or preceded by final waivers from every entity involved with performance of the Work covered by the application who is lawfully entitled to a lien.
- F. Final Payment Application: Submit final Application for Payment with releases and close out supporting documentation.

GENERAL CONDITIONS

- G. Approved payments shall be mailed to the Contractor within 30 days.

4.3 FINAL COMPLETION, ACCEPTANCE, AND PAYMENT

- A. The Owner shall make a final inspection of the Work on receipt of (1) written notice from the Contractor that the Work is ready for final inspection and (2) a final Application for Payment. When the Owner finds the Work acceptable and fully performed under the Contract Documents, and the Contractor has delivered to the Owner all warranties, permits, and operations manuals, the Owner will issue a Notice of Final Completion.
- B. Acceptance of final payment by Contractor, or any Subcontractor, shall constitute a waiver and release to Owner of all claims by Contractor, or any such Subcontractor, for an increase in the Contract Sum or the Contract Time, and for every act or omission of Owner relating to or arising out of the Work, except for those Claims made in accordance with the procedures, including the time limits, set forth in PART 7 - .

PART 5 - CHANGES

5.1 CHANGE IN THE WORK

- A. Owner may, at any time and without notice to Contractor's surety, order additions, deletions, revisions, or other changes in the Work. These changes in the Work shall be incorporated into the Contract Documents through the execution of Change Orders. If any change in the Work ordered by Owner causes an increase or decrease in the Contract Sum or the Contract Time, an equitable adjustment shall be made as provided in 5.2 and 5.3.
- B. Pending agreement on the terms of the Change Order, Owner may direct Contractor to proceed immediately with the Change Order Work. Contractor shall not proceed with any change in the Work until it has obtained Owner's written approval.
- C. The Contractor agrees that any change in the Contract Amount or Contract Time provided in a Change Order is full and complete compensation to the Contractor for the change(s) to the work, deleted work, modified work, direct or indirect impact on the Contractor's schedule, and for any equitable adjustment or time extension to which the Contractor may be entitled to in the Change Order, pursuant to the Contract between the Owner and Contractor.

5.2 CHANGE IN THE CONTRACT SUM

- A. Change Order Pricing - Fixed Price: When the fixed price or time and materials method is used to determine the value of any Work covered by a Change Order, or of a request for an equitable adjustment in the Contract Sum, the following procedures shall apply:
 - 1. Contractor's Change Order proposal, or request for adjustment in the Contract Sum, shall be accompanied by a complete itemization of the costs, including labor, material, subcontractor costs, and overhead and profit. The costs shall be itemized in the manner set forth below, and shall be submitted on breakdown sheets with documentation in a form approved by Owner.
 - 2. Any request for adjustment of Contract Sum shall include only the following items:
 - a. Craft labor costs for Contractors and Subcontractors.
 - 1) Basic wages and benefits: Hourly rates and benefits according to applicable prevailing wages.
 - 2) Direct supervision shall not to exceed 15% of the cost of direct labor. No supervision markup shall be allowed for a working supervisor's hours.
 - 3) Worker's Insurance. Direct contributions to the State for industrial insurance, medical aid, and supplemental pension by the class and rates established by L&I.
 - 4) Federal Insurance. Direct contributions required by the Federal Insurance Compensation Act; Federal Unemployment Tax Act; and the State Unemployment Compensation Act.
 - 5) Safety and small tools: 4% of the sum of the amounts calculated in (1), (2), and (3) above.

GENERAL CONDITIONS

- b. **Material Costs:** Material costs and applicable sales tax shall be developed from actual known costs, supplier quotations or standard industry pricing guides and shall consider all available discounts. Freight costs, express charges, or special delivery charges shall be itemized.
- c. **Equipment Costs:** Itemization of the type of equipment and the estimated or actual length of time the equipment appropriate for the Work is or will be used on the change in the Work. Costs will be allowed for equipment and applicable sales tax only if used solely for the changed Work, or for additional rental costs actually incurred by the Contractor. The Date Quest Rental Rate (Blue Book) shall be used as a basis for establishing rental rates of equipment not listed in the above sources. The maximum rate for standby equipment shall not exceed 50% of the applicable rate.
- d. **Allowance for Overhead:** This allowance shall compensate Contractor for all noncraft labor, temporary construction facilities, field engineering, schedule updating, as-built drawings, home office cost, B&O taxes, office engineering, estimating costs, additional overhead because of extended time and any other cost incidental to the change in the Work. This allowance shall be strictly limited in all cases an amount not to exceed the following:
 - 1) For Contractor, for any Work actually performed by Contractor's own forces, 16% of the cost.
 - 2) For each Subcontractor (including lower tier subcontractors), for any Work actually performed by its own forces, 16% of the cost.
 - 3) For Contractor, for any Work performed by its Subcontractor(s), 6% of the amount due each Subcontractor.
 - 4) For each Subcontractor, for any Work performed by its Subcontractor(s) of any lower tier, 5% of the amount due the sub-Subcontractor.
- e. **Allowance for Profit:**
 - 1) For Contractor or Subcontractor of any tier for work performed by their forces, 5% of the cost developed in accordance with subsections a, b & c above.
 - 2) For Contractor or Subcontractor of any tier for work performed by a subcontractor of a lower tier, 5% of the Subcontractor cost.
- f. **Insurance or Premium:** The costs of any change or additional premium of Contractor's liability insurance or bond premium arising directly from the changed Work. The costs of any change in insurance shall be added after overhead and profit are calculated.

B. Change Order Pricing - Unit Prices

- 1. Work on a unit-price basis as stated in the Specifications and at the price submitted in the Bid Form or as subsequently modified.
 - a. Unit prices shall include reimbursement for all direct and indirect costs of the Work, including overhead and profit, bond premium, and insurance costs; and
 - b. Quantities must be supported by field measurement verified by Owner.

5.3 CHANGE IN THE CONTRACT TIME

- A. The Contract Time shall only be changed by a Change Order. Contractor shall immediately notify Owner, and shall include any request for a change in the Contract Time in its Change Order proposal.
- B. If the time of Contractor's performance is changed due to an act of Force Majeure, Contractor shall request for an equitable adjustment in the Contract Time in writing within 24-hours of the occurrence.

PART 6 - CLAIMS AND DISPUTE RESOLUTION

6.1 CLAIMS PROCEDURE

- A. If the parties fail to reach agreement regarding any dispute arising from the Contract Documents, Contractor's only remedy shall be to file a Claim with Owner within 30 Days from Owner's final offer.

GENERAL CONDITIONS

- B. The Claim shall be deemed to cover all changes in cost and time (including direct, indirect, impact, and consequential) to which Contractor may be entitled. It shall be fully substantiated and documented.
- C. After Contractor has submitted a fully-documented Claim, Owner shall respond, in writing, to Contractor with a decision within 30 Days from the date the Claim is received.
- D. Contractor shall proceed with performance of the Work pending final resolution of any Claim. Owner's written decision as set forth above shall be final and conclusive as to all matters set forth in the Claim.
- E. Any Claim of the Contractor against the Owner for damages, additional compensation, or additional time, shall be conclusively deemed to have been waived by the Contractor unless timely made in accordance with the requirements of this section.

6.2 ARBITRATION

- A. If Contractor disagrees with Owner's decision rendered in accordance with paragraph 6.1C, Contractor shall provide Owner with a written demand for arbitration. No demand for arbitration of any such Claim shall be made later than 30 Days after the date of Owner's decision on such Claim; failure to demand arbitration within said 30 Day period shall result in Owner's decision being final and binding upon Contractor and its Subcontractors.
 - 1. Notice of the demand for arbitration shall be filed with the American Arbitration Association (AAA), with a copy provided to Owner. The parties shall negotiate or mediate under the Voluntary Construction Mediation Rules of the AAA, or mutually acceptable service.
- B. All Claims arising out of the Work shall be resolved by arbitration. The judgment upon the arbitration award may be entered, or review of the award may occur, in the superior court having jurisdiction thereof. No independent legal action relating to or arising from the Work shall be maintained.

6.3 CLAIMS AUDITS

- A. All Claims filed against Owner shall be subject to audit at any time following the filing of the Claim. Failure of Contractor, or Subcontractors of any tier, to maintain and retain sufficient records to allow Owner to verify all or a portion of the Claim or to permit Owner access to the books and records of Contractor, or Subcontractors of any tier, shall constitute a waiver of the Claim and shall bar any recovery.
 - 1. In support of Owner audit of any Claim, Contractor shall promptly make available to Owner all records relating to the Work.

PART 7 - TERMINATION OF THE WORK

7.1 TERMINATION BY OWNER FOR CAUSE

- A. Owner may, upon a written Notice to Contractor and to its surety, terminate (without prejudice to any right or remedy of Owner) the Work, or any part of it, for cause upon the occurrence of any one or more of the following events:
 - 1. Contractor fails to prosecute the Work or any portion thereof with sufficient diligence to ensure Completion of the Work within the Contract Time;
 - 2. Contractor is adjudged bankrupt, makes a general assignment for the benefit of its creditors, or a receiver is appointed on account of its insolvency;
 - 3. Contractor fails in a material way to replace or correct Work not in conformance with the Contract Documents;
 - 4. Contractor repeatedly fails to supply skilled workers or proper materials or equipment;
 - 5. Contractor repeatedly fails to make prompt payment due to Subcontractors, suppliers, or for labor;
 - 6. Contractor materially disregards or fails to comply with laws, ordinances, rules, regulations, or orders of any public authority having jurisdiction; or
 - 7. Contractor is otherwise in material breach of any provision of the Contract Documents.

GENERAL CONDITIONS

- B. Upon termination, Owner may at its option:
 - 1. Take possession of the Project site and take possession of or use all materials, equipment, tools, and construction equipment and machinery thereon owned by Contractor to maintain the orderly progress of, and to finish, the Work;
 - 2. Finish the Work by whatever other reasonable method it deems expedient.
- C. Owner's rights and duties upon termination are subject to the prior rights and duties of the surety, if any, obligated under any bond provided in accordance with the Contract Documents.
- D. When Owner terminates the Work in accordance with this section, Contractor shall take the actions set forth in paragraph 7.2B, and shall not be entitled to receive further payment until the Work is accepted.
- E. If the unpaid balance of the Contract Sum exceeds the cost of finishing the Work, including compensation for A/E services and expenses made necessary thereby and any other extra costs or damages incurred by Owner in completing the Work, or as a result of Contractor's actions, such excess shall be paid to Contractor. If such costs exceed the unpaid balance, Contractor shall pay the difference to Owner. Contractor shall also be liable for liquidated damages until such reasonable time as may be required for Completion. These obligations for payment shall survive termination.
- F. Termination of the Work in accordance with this section shall not relieve Contractor or its surety of any responsibilities for Work performed.
- G. If Owner terminates Contractor for cause, and it is later determined that none of the circumstances set forth in 7.1A exist, then such termination shall be deemed a termination for convenience pursuant to 7.2.

7.2 TERMINATION BY OWNER FOR CONVENIENCE

- A. Owner may, upon Notice, terminate (without prejudice to any right or remedy of Owner) the Work, or any part of it, for the convenience of Owner.
- B. Unless Owner directs otherwise, after receipt of a Notice of termination for either cause or convenience, Contractor shall promptly:
 - 1. Stop performing Work on the date and as specified in the notice of termination;
 - 2. Place no further orders or subcontracts for materials, equipment, services or facilities, except as may be necessary for completion of such portion of the Work as is not terminated;
 - 3. Cancel all orders and subcontracts, upon terms acceptable to Owner, to the extent that they relate to the performance of Work terminated;

PART 8 - MISCELLANEOUS PROVISIONS

8.1 RECORDS KEEPING AND REPORTING

- A. The Contractor and all Subcontractors shall maintain accounts and records in accordance with State Auditor's procedures, including personnel, property, financial and programmatic records which sufficiently and properly reflect all direct and indirect costs of any nature expended and services performed in the performance of this Contract and other such records as may be deemed necessary by the Owner to ensure proper accounting for all funds contributed by the Owner to the performance of this Contract and compliance with this Contract.
- B. The Contractor, and its Subcontractors, shall maintain these records for a period of six (6) years after the date of Final Acceptance.

8.2 AUDITS AND INSPECTIONS

- A. The records and documents with respect to all matters covered by this Contract shall be subject at all times to inspection, review or audit by the Owner or any other government agency so authorized by law during the performance of this Contract. The Owner shall have the right to an annual audit of the Contractor's financial statement and condition.

GENERAL CONDITIONS

8.3 ORGANIZATION CONFLICTS OF INTEREST

- A. The Contractor warrants that to the best of its knowledge and belief and except as otherwise disclosed, it does not have any organizational conflict of interest which is defined as a situation in which the nature of work under this Contract and the Contractor's organizational, financial, contractual or other interests are such that:
 - 1. Award of the Contract may result in an unfair competitive advantage; or
 - 2. The Contractor's objectivity in performing the Contract work may be impaired.
- B. The Contractor agrees that if after award they discover an organizational conflict of interest with respect to this Contract, they shall make an immediate and full disclosure in writing to the Contracting Officer, which shall include a description of the action, which the Contractor has taken or intends to take to eliminate or neutralize the conflict. The Owner may, however, terminate the Contract if it deems the action to be in the best interest of the Owner.
- C. In the event the Contractor was aware of an organizational conflict of interest before the award of this Contract and intentionally did not disclose the conflict to the Contracting Officer, the Owner may terminate the Contract for default.
- D. The provisions of this Clause shall be included in all subcontracts and consulting agreements wherein the work to be performed is similar to the services provided by the Contractor. The Contractor shall include in such subcontracts and consulting agreements any necessary provisions to eliminate or neutralize conflicts of interest.

8.4 INTERESTS OF MEMBERS OF CONGRESS

- A. No member of or delegate to the Congress of the United States of America shall be admitted to any share or part of this Contract or to any benefit to arise therefrom, but this provision shall not be construed to extend to this Contract if made with a corporation for its general benefit.

8.5 INTERESTS OF MEMBERS, OFFICERS, COMMISSIONERS AND EMPLOYEES, OR FORMER MEMBERS, OFFICERS AND EMPLOYEES

- A. No member, officer, or employee of the King County Housing Authority, no member of the governing body of the locality in which the project is situated, no member of the governing body in which the Owner was activated, and no other public official or such locality or localities who exercises any functions or responsibilities with respect to the project, shall, during his or her tenure, or for one year thereafter, have any interest, direct or indirect, in this Contract or the proceeds thereof.

BID FORM

PROJECT NAME AND LOCATION:

**Emerson Apartments
Fireplace & Bathroom Fan Replacement**

Contract Number: DW2400431

BID FORM

The undersigned, Legal Name of Bidder: _____

on this date: _____, 2024, having familiarized him/herself with the contract documents, site conditions, and has field verified all measurements contained in the project manual as prepared by the Owner, hereby proposes to furnish labor, materials and necessary equipment – all including, but not limited to, demolition, disposal, new installation and the required applicable taxes and fees to complete the work for the following bid amounts:

BASE BID _____ (\$ _____)
(Including sales tax indicated in Instructions to Bidders)

ADDENDA _____
Acknowledge receipt of any addenda by inserting the number(s) above

In submitting this bid, it is understood that the right is reserved by the Owner to reject any and all bids. The undersigned hereby agrees that this proposal shall be a valid and firm offer for a period of Sixty (60) calendar days from the date of Bid Opening.

Bidder agrees that Work will be substantially complete and ready for final payment in accordance with the Contract Documents on or before the date, within the number of calendar days indicated.

The undersigned Bidder hereby certifies that, within the three-year period immediately preceding the bid solicitation date for this Project, the bidder is not a “willful” violator, as defined in RCW 49.48.082, of any provision of chapters 49.46, 49.48, or 49.52 RCW, as determined by a final and binding citation and notice of assessment issued by the Department of Labor and Industries or through a civil judgment entered by a court of limited or general jurisdiction.

I certify (or declare) under penalty of perjury under the laws of the State of Washington that the foregoing is true and correct.

Signature of Bidder

Print Your Name

Submitted on _____ day of _____ 2024

City

State

BIDDER INFORMATION

BIDDER INFORMATION

Name of Bidder (Company): _____

Address: _____

Contact Name: _____

Phone Number: _____ Email Address: _____

Business Type: General Contractor () Other () (Please specify): _____

Bidder is a(n): Individual Partnership Joint Venture Incorporated in the state of _____

List business names & associated UBI # used by Bidder during the past 5 years if different than above:

Bidder has been in business continuously from: _____
Month, Year

Business License #: _____ Federal ID #: _____

Current UBI #: _____ Dept. of L&I Worker's Comp. Acct. #: _____

Bidder has experience in work "Similar in Scope and Complexity" comparable to that required for this Project:

As a prime contractor for _____ years. As a subcontractor for _____ years.

OWNER(S) OF COMPANY (List all owners):	OWNER'S SOCIAL SECURITY NUMBER (only required if sole proprietorship):

No. of regular full-time employees other than owner(s): _____

Indicate clearly the kind of work your company will actually perform in this project:

Approximate % of work your company will actually perform: _____

List the supervisory personnel to be employed by the Bidder and available for, and intended to, work on this project:

<u>Name</u>	<u>Title</u>	<u>How Long With Bidder</u>

BIDDER INFORMATION

SUBCONTRACTORS

Do you intend to use Subcontractor(s) in this project? Yes No (If yes, you must show the name of the subcontractors. Attach additional pages as necessary.)

Subcontractors Name	Subcontractor's UBI#	Phone Number	Trade	Years in Business
1.				
2.				
3.				
4.				
5.				

BIDDER'S EXPERIENCE

Projects successfully supervised and completed by your company for work of similar scope and value as specified in bid documents in the last 5 years. Attach additional pages as necessary.

Name of Project	Completion Date	Duration (Months)	Nature of Work	Amount of Contract
1.				
2.				
3.				
4.				
5.				

Owner's Name (of project listed above)	Project Address	Contact Person	Phone Number
1.			
2.			
3.			
4.			
5.			

Has Bidder ever been found guilty of violating any State or Federal employment laws? No Yes
If yes, give details & attach additional pages as necessary:

Has Bidder ever filed for protection under any provision of the federal bankruptcy laws or state insolvency laws?
 No Yes If yes, give details & attach additional pages as necessary:

BIDDER INFORMATION

Has any lien, claim and/or adverse legal action related to construction been rendered against Bidder in the past five years? (i.e., open claims, lawsuits, warrants, judgements including but not limited to those that would show on the L&I website) No Yes If yes, give details & attach additional pages as necessary:

Has Bidder or any of its employees filed any claims with Washington State Worker's Compensation or other insurance company for accidents resulting in fatal injury or dismemberment in the past 5 years? No Yes
If yes, please state:

<u>Date</u>	<u>Type of Injury</u>	<u>Agency Receiving Claim</u>
_____	_____	_____
_____	_____	_____

Bidders current Experience Modification Rate (EMR): _____

(If Bidder is self-insured, attach proof of EMR stated, showing complete worksheet calculations)

The bidder hereby certifies that the information contained in this Bidder's Information is accurate, complete and current.

BY: _____ NAME: _____
(signature) (print)

TITLE: _____ DATE: _____

CONTRACT FORM

This Contract is entered into by and between the King County Housing Authority, hereinafter referred to as the “Owner” whose principal office is located at 600 Andover Park West, Seattle, WA 98188 and [Name of Contractor], referred to as the “Contractor”, whose principal office is located at [Contractor’s Address].

IN CONSIDERATION OF the mutual benefits and conditions hereinafter contained, the parties hereto agree as follows:

1.1 Contract Documents

A. The provisions set forth in the Contract Documents are hereby incorporated into and made part of the Contract. Contractor acknowledges receipt and review of all Contract Documents applicable to performance of the work. The Contract shall consist of the following component parts:

1. This Instrument
2. Addenda
3. Specifications
4. Plans
5. Bid Form
6. Pre-Bid Agenda
7. General Conditions
8. Instructions to Bidders
9. Prevailing Wage Rates
10. Hazardous Material Report

1.2 Scope of Services to be Performed by the Contractor: The Contractor shall provide all labor, materials, tools, equipment, transportation, supplies, and incidentals required to complete the work in accordance with the Contract Documents for:

Project: Emerson Apartments Fireplace & Bath Fan Replacement

Contract No.: DW2400431

1.3 Compensation: The total amount of the Contract shall be [\$\$\$] dollars and [¢¢] cents (\$[\$\$\$.\$\$]) subject to additions and deductions provided therein.

1.4 Duration of Contract: The Contractor shall commence work after receipt of Notice to Proceed, follow the schedule specified in the contract documents, and all work must be completed within sixty (60) consecutive calendar days from the date of the Notice to Proceed unless sooner terminated pursuant to the General Conditions. Upon expiration of the original Contract term, the Contract, at the Owner’s sole discretion, may be extended for a period determined by the Owner.

1.5 Liquidated Damages: Timely performance and completion of the Work is essential to Owner and time limits stated in the Contract Documents are of the essence. If Completion of the Work does not occur within the Contract Time, the Contractor agrees that Liquidated Damages in the amount of **\$250.00** per day will be assessed for each calendar day that the Contractor exceeds the time for completion.

The individuals signing this Contract warrant and represent for themselves and for their respective organizations that they are duly authorized to sign this Contract and that upon such signing their respective organizations are bound thereby.

DATED this _____ day of _____, 2024

Contractor

Owner

President/Owner

Robin Walls
President/CEO
KING COUNTY HOUSING AUTHORITY

CERTIFICATE OF INSURANCE

DATE(MM/DD/YY)

Issue Date

PRODUCER Vendor's Insurance Agent Street Address City, State, Zip Phone Number	THIS CERTIFICATE IS ISSUED AS A MATTER OF INFORMATION ONLY AND CONFERS NO RIGHTS UPON THE CERTIFICATE HOLDER. THIS CERTIFICATE DOES NOT AMEND, EXTEND OR ALTER THE COVERAGE AFFORDED BY THE POLICIES BELOW.								
COMPANIES AFFORDING COVERAGE									
	<table border="1" style="width: 100%; border-collapse: collapse;"> <tr> <td style="width: 15%; text-align: center;">COMPANY A</td> <td>ABC Insurance Company</td> </tr> <tr> <td style="text-align: center;">COMPANY B</td> <td>DEF Insurance Company</td> </tr> <tr> <td style="text-align: center;">COMPANY C</td> <td>GHI Insurance Company</td> </tr> <tr> <td style="text-align: center;">COMPANY D</td> <td></td> </tr> </table>	COMPANY A	ABC Insurance Company	COMPANY B	DEF Insurance Company	COMPANY C	GHI Insurance Company	COMPANY D	
COMPANY A	ABC Insurance Company								
COMPANY B	DEF Insurance Company								
COMPANY C	GHI Insurance Company								
COMPANY D									

COVERAGES
 THIS IS TO CERTIFY THAT THE POLICIES OF INSURANCE LISTED BELOW HAVE BEEN ISSUED TO THE INSURED NAMED ABOVE FOR THE POLICY PERIOD INDICATED. NOTWITHSTANDING ANY REQUIREMENT, TERM OR CONDITION OF ANY CONTRACT OR OTHER DOCUMENT WITH RESPECT TO WHICH THIS CERTIFICATE MAY BE ISSUED OR MAY PERTAIN, THE INSURANCE AFFORDED BY THE POLICIES DESCRIBED HEREIN IS SUBJECT TO ALL THE TERMS, EXCLUSIONS AND CONDITIONS OF SUCH POLICIES. LIMITS SHOWN MAY HAVE BEEN REDUCED BY PAID CLAIMS.

CO LTR	TYPE OF INSURANCE	POLICY NUMBER	POLICY EFFECTIVE DATE (MM/DD/YY)	POLICY EXPIRATION DATE (MM/DD/YY)	LIMITS
A	GENERAL LIABILITY	XXX123	01/01/00	01/01/01	GENERAL AGGREGATE 2,000,000
	<input checked="" type="checkbox"/> COMMERCIAL GENERAL LIABILITY				PRODUCTS-COMP/OP AGG 1,000,000
	<input type="checkbox"/> CLAIMS MADE <input checked="" type="checkbox"/> OCCUR				PERSONAL & ADV INJURY 1,000,000
	<input type="checkbox"/> OWNER'S & CONTRACTOR'S PROT				EACH OCCURRENCE 1,000,000
					FIRE DAMAGE (Any one fire) 50,000
					MED EXP (Any one person) 5,000
B	AUTOMOBILE LIABILITY	XXX456	01/01/00	01/01/01	COMBINED SINGLE LIMIT 1,000,000
	<input checked="" type="checkbox"/> ANY AUTO				BODILY INJURY (Per person)
	<input type="checkbox"/> ALL OWNED AUTOS				BODILY INJURY (Per accident)
	<input type="checkbox"/> SCHEDULED AUTOS				PROPERTY DAMAGE
	<input checked="" type="checkbox"/> HIRED AUTOS				
<input type="checkbox"/> NON-OWNED AUTOS					
GARAGE LIABILITY					AUTO ONLY-EA ACCIDENT
<input type="checkbox"/> ANY AUTO					OTHER THAN AUTO ONLY:
					EACH ACCIDENT
					AGGREGATE
EXCESS LIABILITY					EACH OCCURRENCE
<input type="checkbox"/> UMBRELLA FORM					AGGREGATE
<input type="checkbox"/> OTHER THAN UMBRELLA FORM					
C	WORKERS' COMPENSATION AND EMPLOYER'S LIABILITY	XXX789	01/01/00	01/01/01	<input checked="" type="checkbox"/> STATUTORY LIMITS
	<input type="checkbox"/> THE PROPRIETOR/PARTNERS/EXECUTIVE OFFICERS ARE: <input type="checkbox"/> INCL <input type="checkbox"/> EXCL				EACH ACCIDENT 1,000,000
					DISEASE-POLICY LIMIT 1,000,000
					DISEASE-EACH EMPLOYEE 1,000,000
OTHER					

DESCRIPTION OF OPERATIONS/LOCATIONS/VEHICLES/SPECIAL ITEMS
Security Properties Residential and King County Housing Authority are named as additional insureds with respect to above general liability and auto coverage. Re: Contract DW2400431 at Emerson Apartments 11010 NE 124th Ln, Kirkland, WA 98034.

CERTIFICATE HOLDER Security Properties Residential King County Housing Authority 600 Andover Park West Seattle, WA 98188-3326	CANCELLATION SHOULD ANY OF THE ABOVE DESCRIBED POLICIES BE CANCELED BEFORE THE EXPIRATION DATE THEREOF, THE ISSUING COMPANY WILL ENDEAVOR TO MAIL 30 DAYS WRITTEN NOTICE TO THE CERTIFICATE HOLDER NAMED TO THE LEFT, BUT FAILURE TO MAIL SUCH NOTICE SHALL IMPOSE NO OBLIGATION OR LIABILITY OF ANY KIND UPON THE COMPANY, ITS AGENTS OR REPRESENTATIVES. AUTHORIZED REPRESENTATIVE Signature of Insured's Agent
--	---

PROVIDE

**GENERAL LIABILITY
ENDORSEMENT**

and

**AUTO LIABILITY
ENDORSEMENT**