



Board of Commissioners
Doug Barnes, *Chair*
Susan Palmer, *Vice-Chair*
John Welch
TerryLynn Stewart
Regina Elmi

Executive Director/CEO
Robin Walls

INVITATION TO BID

Pool Resurface & Renovation
at
Argyle Apartments, 2517 South 316th Lane, Federal Way, WA 98003

January 6, 2023

ADDENDUM NO. 1

This addendum is used to clarify, change, delete, add to or substitute items in the original contract documents.

BID DATE: February 1, 2023 at 2:00 pm

QUESTIONS DEADLINE: Wednesday, January 25, 2023

NUMBER OF PAGES: 5 ATTACHMENT: Stegmeier Frontier PVC Drain

CONTRACT NUMBER: DW2300631

NOTICE TO BIDDERS: Bidders are hereby notified of the following changes and/or clarifications to the Contract Documents for this project:

The specifications include the following information about the pool deck strip drain.

Section 02630 - DRAINAGE

2.1 DRAIN, PIPES AND FITTINGS

- A. Kent Curved Slot Drain or Duratech Radius Strip Drain: Follow manufacturer's recommendations.

The revised specification should read:

- A. Stegmeier Frontier PVC Drain, Gray, SDDG in 10' lengths, joined with standard Stegmeier Frontier parts, installed per manufacturer's recommendations.
(See attached instructions and sectional details, 3 documents.)

All other provisions of the Contract Documents remain unchanged.

END OF ADDENDUM NO. 1

STEGMEIER[®]

LLC

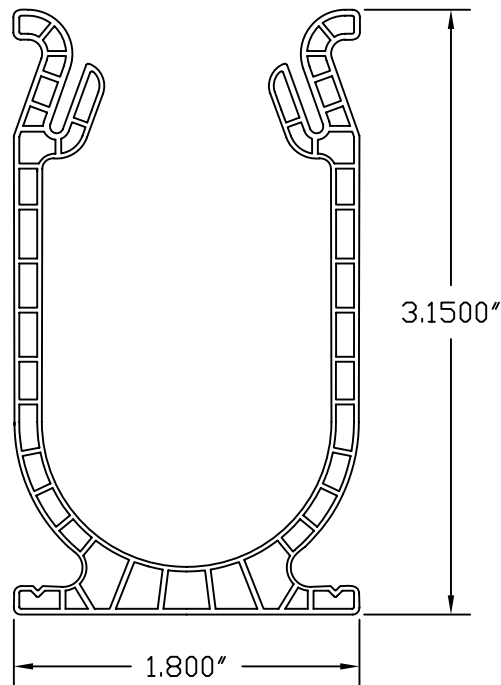
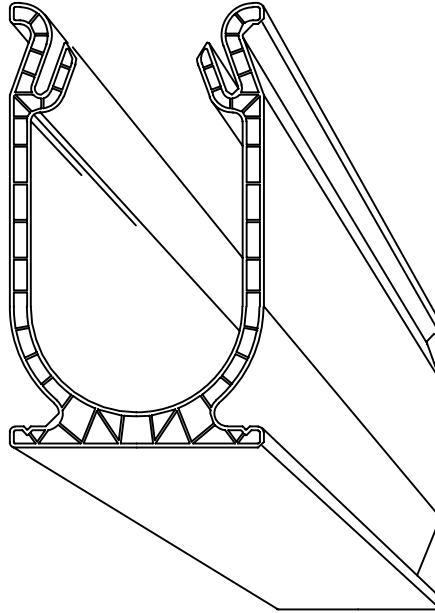

Frontier Deck Drain Base Treadmaster Commercial Drain Base

CORPORATE OFFICE 1111 West Harris Road • Arlington, TX 76001 • (800) 382-5430
www.stegmeier.com

Note all units in inches

DOWNLOAD THE STEGMEIER LLC APP  

FRONTIER DECK DRAIN INSTRUCTIONS

Instructions applicable to all Stegmeier LLC removable top Deck Drains Products

SITE PREPARATION: GRADE SUBSOIL WITH APPROPRIATE FALL TOWARD DRAIN AREA



A. Using a string line, drive 3 inch stakes along the path of the drain every 30 inches.



B. Using P.V.C. primer and cement on both the drain and the couplings, weld them into one piece.



C. Using nails or sheet rock screws, fasten the drain to the 3 inch stakes that have been set to grade.

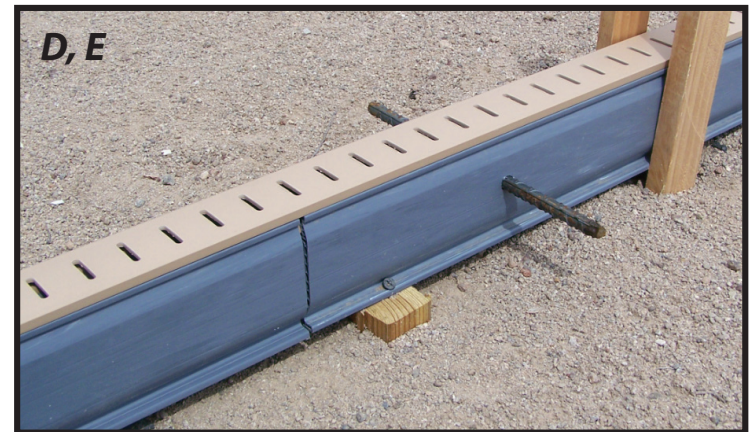

D. Install the top cap, making sure to "half-lap" the top past the joints to insure rigidity. Add additional stakes on either side of the drain to temporarily support the drain during the pour.

E. Using 3/8" Stegmeier Drain Dowel, drill and pin (midway through the base) every 3 feet to ensure against possible damage to the drain due to deck movement.

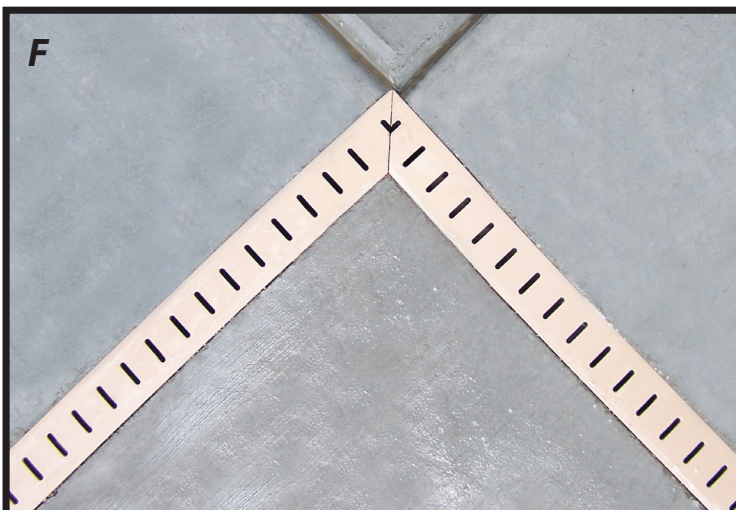

F. The fittings (90 degree, 45 degree, etc.) are supplied as "base only". During installation, the top caps (10 ft. long) run continuously over the fittings serving as a mounting device, leaving the fittings virtually invisible.

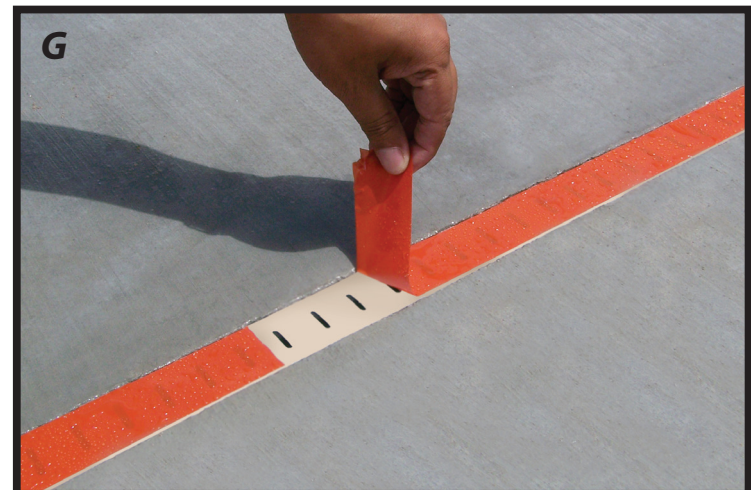

G. Remove the protective tape after the concrete installation is complete.

Caution: Leaving the protective tape in place for an extended period of time may result in the tape being difficult to remove.

EASY ACCESS/ MAINTENANCE

SNUG FITTING CAPS

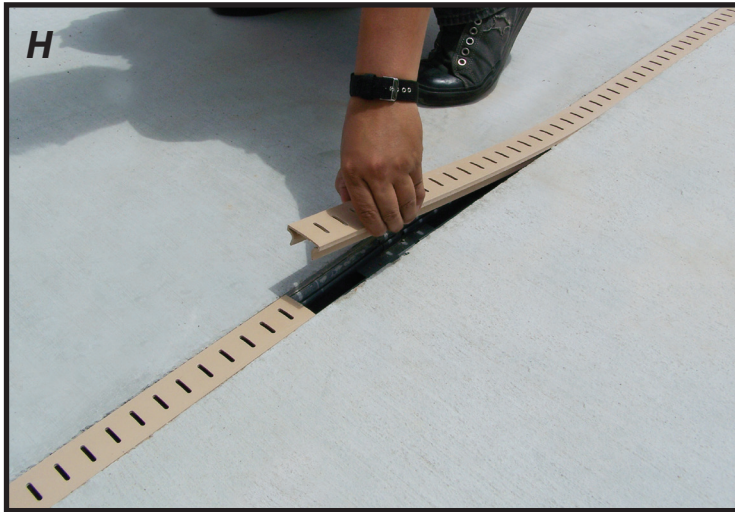

CLEAN OUT ACCESS

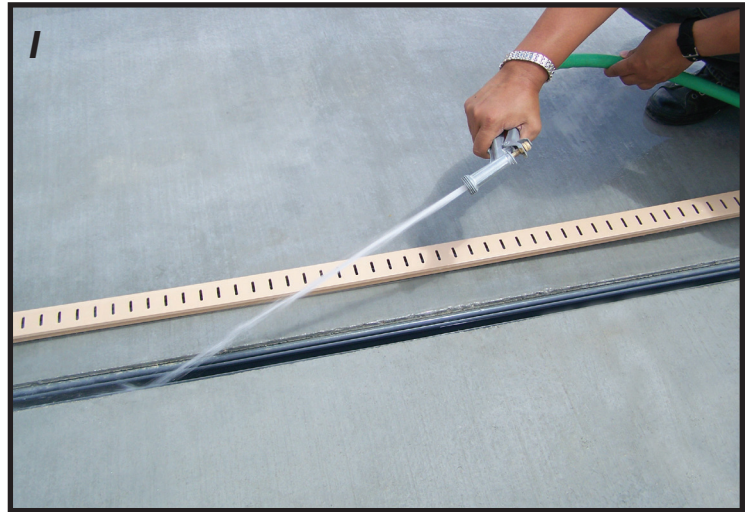

H, I. The top caps can be easily removed for cleaning or replacement. The top cap snaps in and out using the flex in the top cap legs. This unique attachment has no external fasteners (screws) that detract from the attractive appearance.

The Wet Pad Option

J. Using a string line, stake the drain into place. Fasten the drain to elevation temporarily, using screws or nails as needed. See Fig. J

K. Using sand and cement (mixed on site) apply a shovel full of mortar to each side of the drain 3 foot on center or as needed. See Fig. K

Using a trowel, push the mortar against the drain, making sure that the mortar does not extend above the top of the drain. See Fig. K

Many contractors prefer using the wet pad method because of the following advantages:

1. Provides a more stable surface to screed on.
2. Many municipalities prohibit leaving wooden stakes in the subsoil.

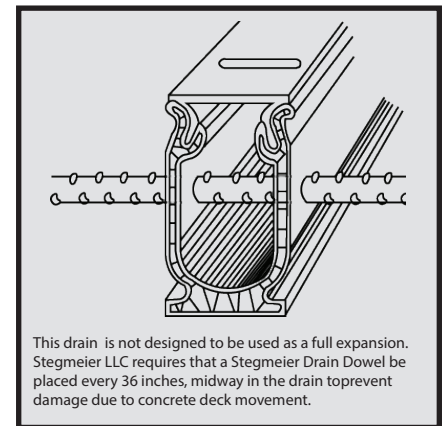

This drain is not designed to be used as a full expansion. Stegmeier LLC requires that a Stegmeier Drain Dowel be placed every 36 inches, midway in the drain to prevent damage due to concrete deck movement.

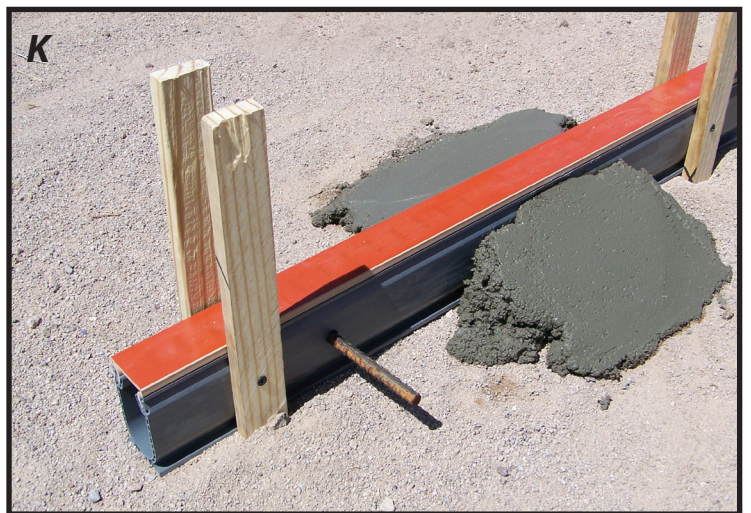

STEGMEIER[®]

LLC

1111 W. Harris Rd. Arlington TX, 76001
Customer Service - 800-382-5430 • Toll-free Fax - 800-356-3602
www.stegmeier.com

STEGMEIER LLC

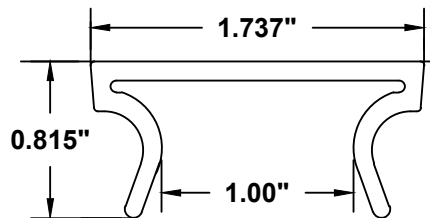

Frontier Deck Drain PVC Top Cap

CORPORATE OFFICE 1111 West Harris Road Arlington, TX 76001 (800) 382-5430
www.stegmeier.com

NOTE ALL UNITS IN INCHES